

ASSEMBLY INSTRUCTION

STARREY
Accent Chair
ITEM CODE 86937

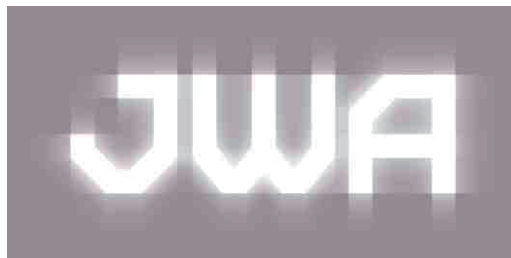

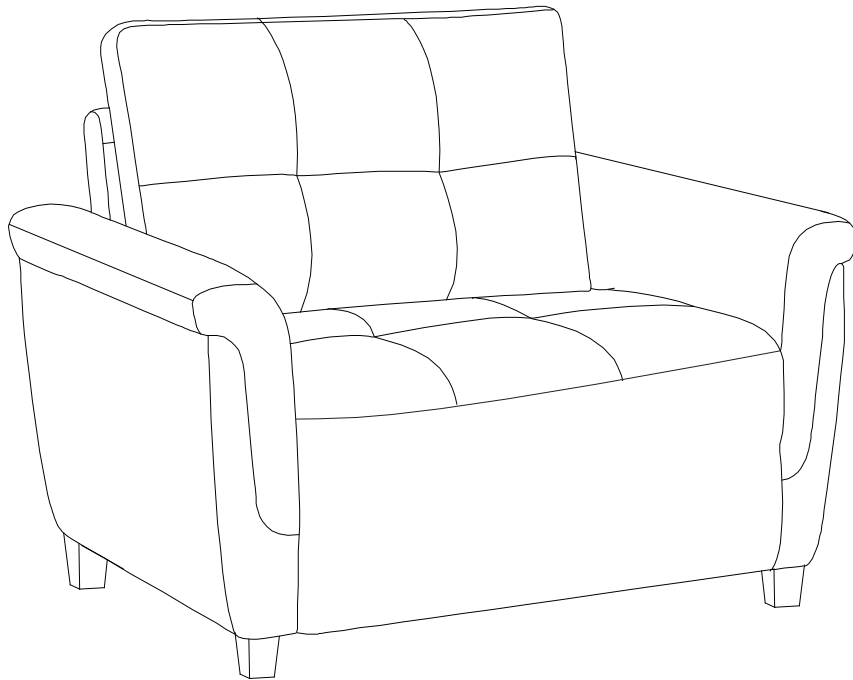

Imported by JWA Furniture Pty Ltd, Brisbane Qld, Australia.
For any assistance with assembly or for missing parts please refer to your receipt



PRE-ASSEMBLY PREPARATION

Before you start:

1. Choose a clean, level, spacious assembly area. Avoid hard surfaces that may damage the product
2. Take care when lifting. Product should be assembled as near as possible to the point of use
3. Ensure that you have all required contents for complete assembly
4. Always read the assembly instructions carefully before beginning assembly.
5. Keep all hardware parts and packaging out of reach of small children.
6. Do not over tighten the screws and bolts as this may damage the threads
7. Assembly is to be carried out by a competent adult(s) ONLY
8. During assembly, children should be kept away from the product due to possible risk to injury.
9. Do not use this item if any components are missing or damaged.
10. Please keep the instructions for future reference.

	
Allow 15 min	For 2 People

PARTS AND HARDWARE

NO	Leg parts	QTY
A		4
B		4
C		1

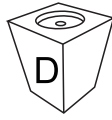

Leg
QTY:4

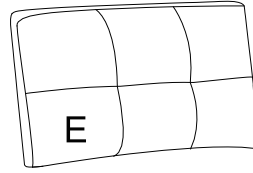

BackCushion
QTY:1

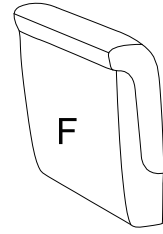

Left Arm
QTY:1

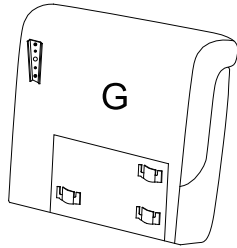

Right Arm
QTY:1

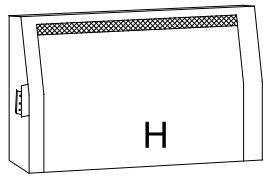

Backrest
QTY:1

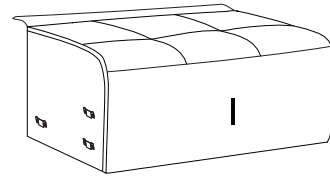

Sofa Body
QTY:1

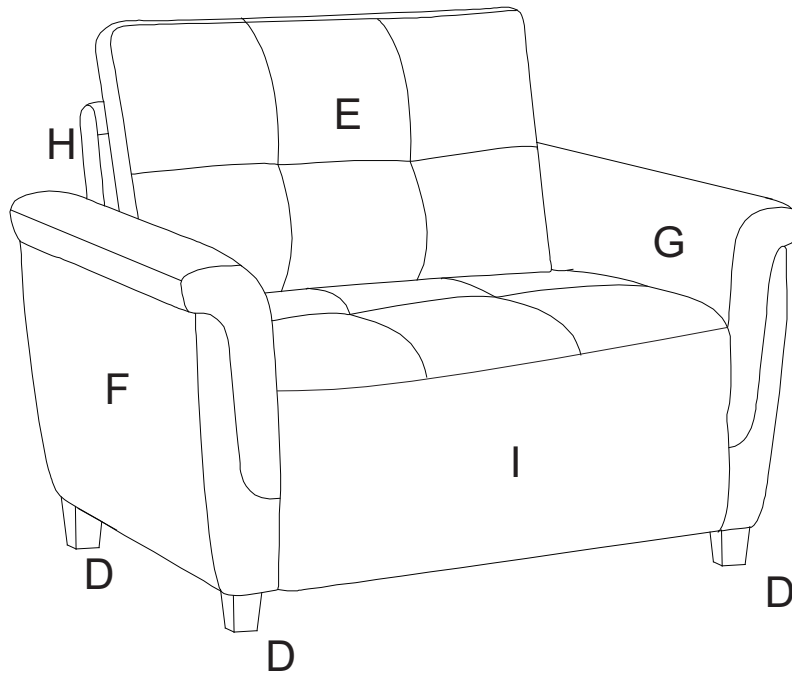

STEP 1

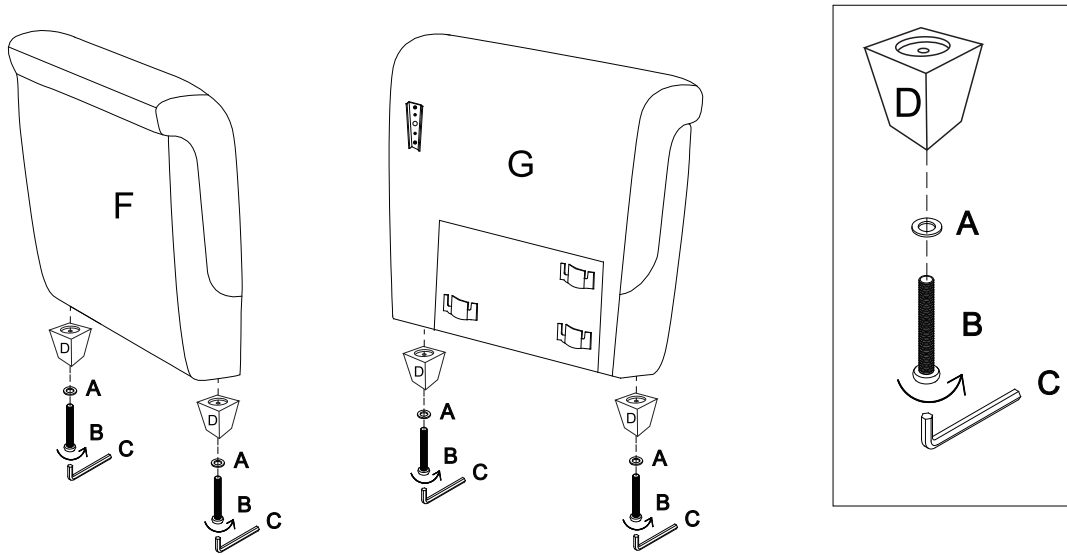

STEP 2

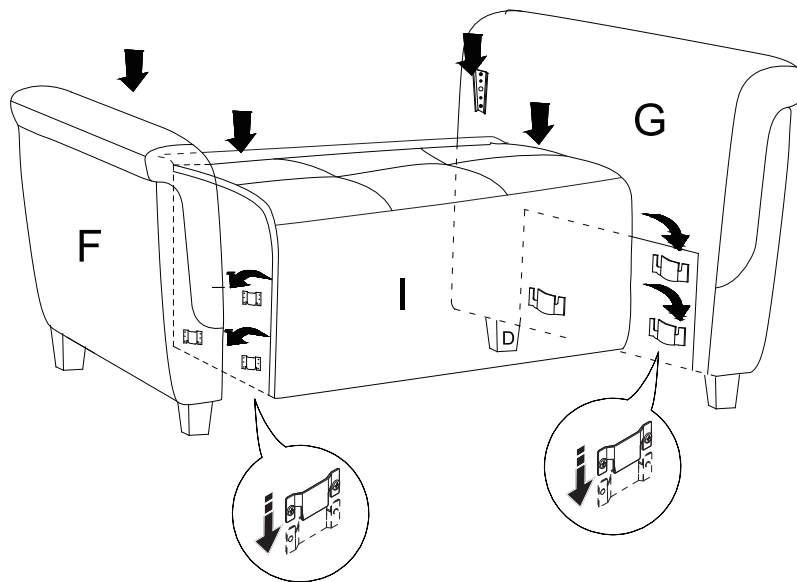

STEP 3

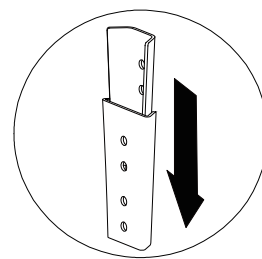
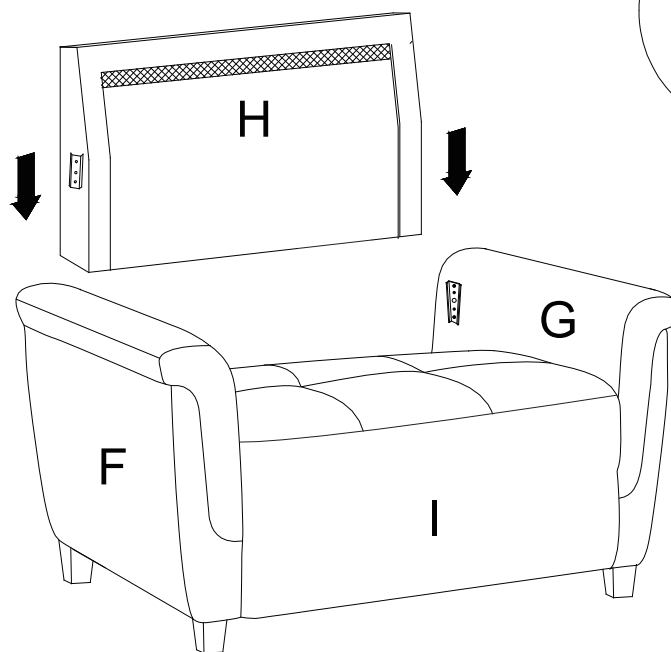

STEP 4

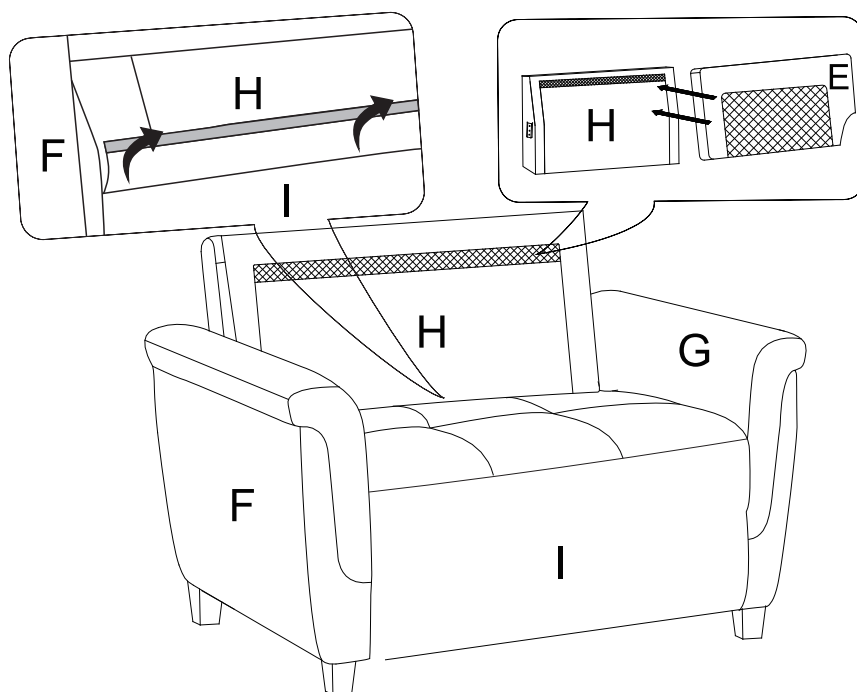

ASSEMBLY IS COMPLETE

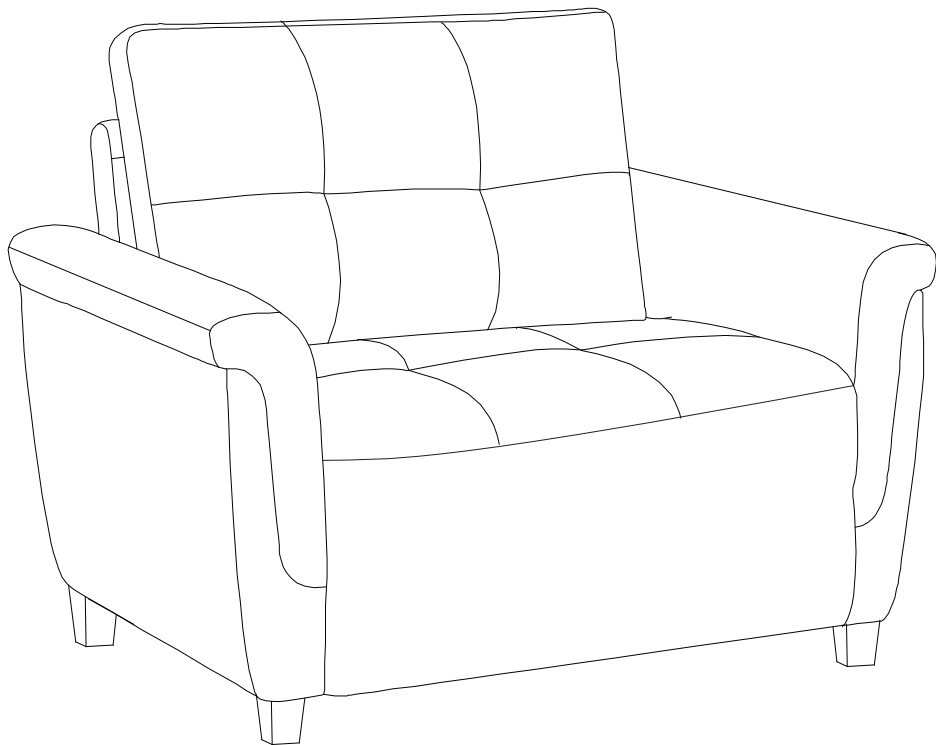

PRODUCT CARE:

REGULAR CARE:

- Protect from direct sunlight
- Vacuum regularly using low suction
- Rotate reversible cushions regularly
- Avoid exposure to new clothing, cushions or throws as this may lead to dye transfer and permanent staining

CLEANING:

- Do not remove cushion covers for separate cleaning even though they may have zippers
- Do not wash, Do not dry clean, Do not shampoo clean
- Clean only with hot water extraction machine. Professional cleaning recommended
- Do not use dishwashing liquid or laundry detergent. Use only upholstery detergents
- Do not wet filling
- Dry in shade away from direct heat and sunlight
- Allow to dry thoroughly before re-use

SPOT CLEANING:

- Do not rub
- Do not spot clean with any solvent
- Treat spills and stains as soon as possible
- Gently scrape off any soil or blot any liquid from the surface of the fabric before applying cleaner
- Apply proprietary cleaning agents strictly according to instructions to remove the residue of the spill
- Do not saturate the fabric or interior with water or other cleaning liquids

WARNING:

Apply only water-based soil resist (fabric protection) treatments. Do not use aerosol products

* PILLING IS NOT A FABRIC DEFECT OR FAULT AND IS NOT COVERED BY WARRANTY

* PILLING IS A NORMAL OCCURRENCE CAUSED BY WEAR AND TEAR AND DOES NOT AFFECT THE DURABILITY OR FUNCTIONALITY OF THE FABRIC AND IS EASILY REMOVED