

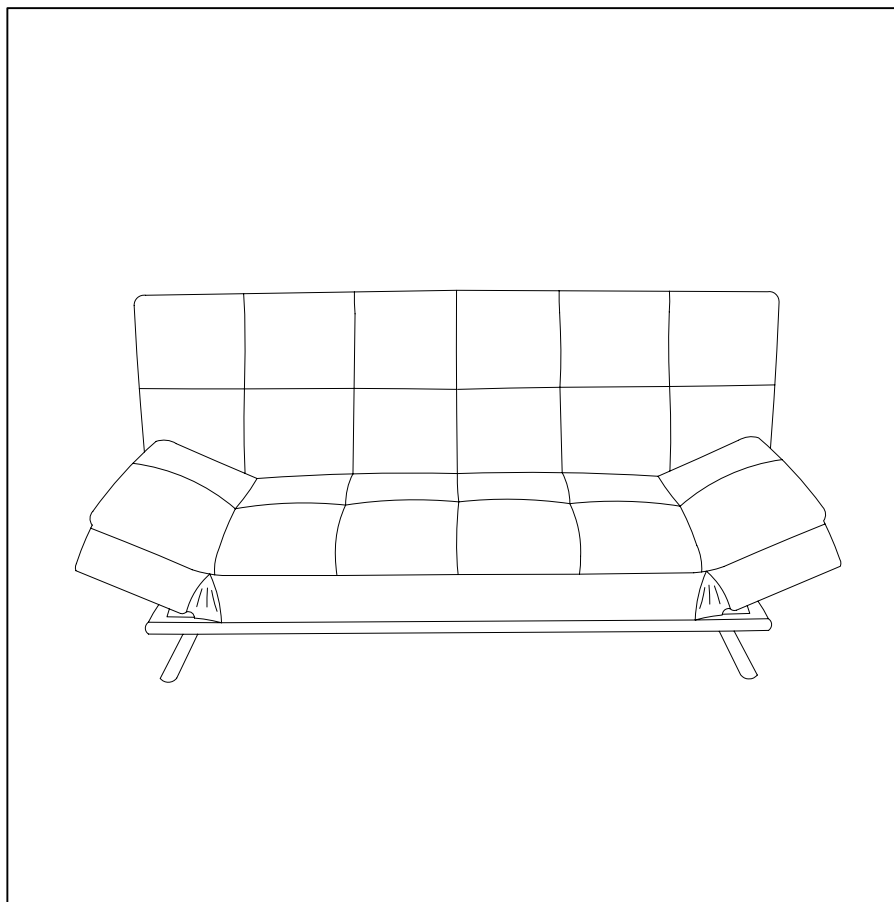

ASSEMBLY INSTRUCTION  
AXEL SOFA BED  
ITEM CODE 65535

Imported by Amart furniture Pty Ltd, Qld, Brisbane Australia.  
For any assistance with assembly or for missing parts please phone  
Amart furniture, Customer Service Free call 1800 351 084



Imported by Amart Furniture Pty Ltd, Qld, Brisbane Australia.  
For any assistance with assembly or for missing parts please phone  
Amart Furniture, Customer Service Free Call 1800 351 084

# PRE-ASSEMBLY PREPARATION



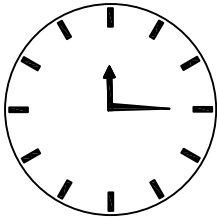
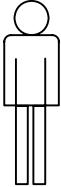

## Before you start:

1. Choose a clean, level, spacious assembly area. Avoid hard surfaces that may damage the product
2. Take care when lifting. Product be assembled as near as possible to the point of use
3. Ensure that you have all required contents for complete assembly
4. Always read the assembly instructions carefully before beginning assembly
5. Keep all hardware parts and packaging out of small children
6. Do not over tighten the screws and bolts as this may damage the threads

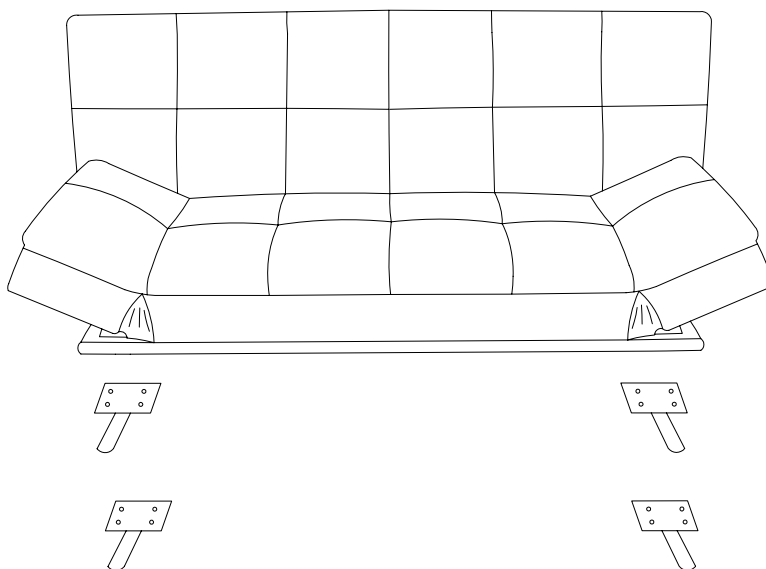
|                                                                                     |                                                                                      |
|-------------------------------------------------------------------------------------|--------------------------------------------------------------------------------------|
|  |  |
| ALLOW 15 MINUTES                                                                    | 2 PEOPLE REQUIRED                                                                    |
|                                                                                     |                                                                                      |

# PARTS LIST

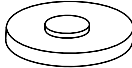

|                                                                                                                               |                                                                                                                                |
|-------------------------------------------------------------------------------------------------------------------------------|--------------------------------------------------------------------------------------------------------------------------------|
| <p>A.1PC</p>  <p>Seater</p>                | <p>B.4PC</p>  <p>Leg</p>                    |
| <p>C.16PCS (M8)</p>  <p>SpringWasher</p>   | <p>D.16PCS(M8*19mm)</p>  <p>Flat washer</p> |
| <p>E.16PCS(M8*15mm)</p>  <p>Allen bolt</p> | <p>F.1PC (M5*100mm)</p>  <p>Allen Key</p>   |

**STEP 1** Attach leg(B) to Seat(A) , using bolt(E) with Spring washer(C) and Flat washer(D) , then fasten by Allen key(F)

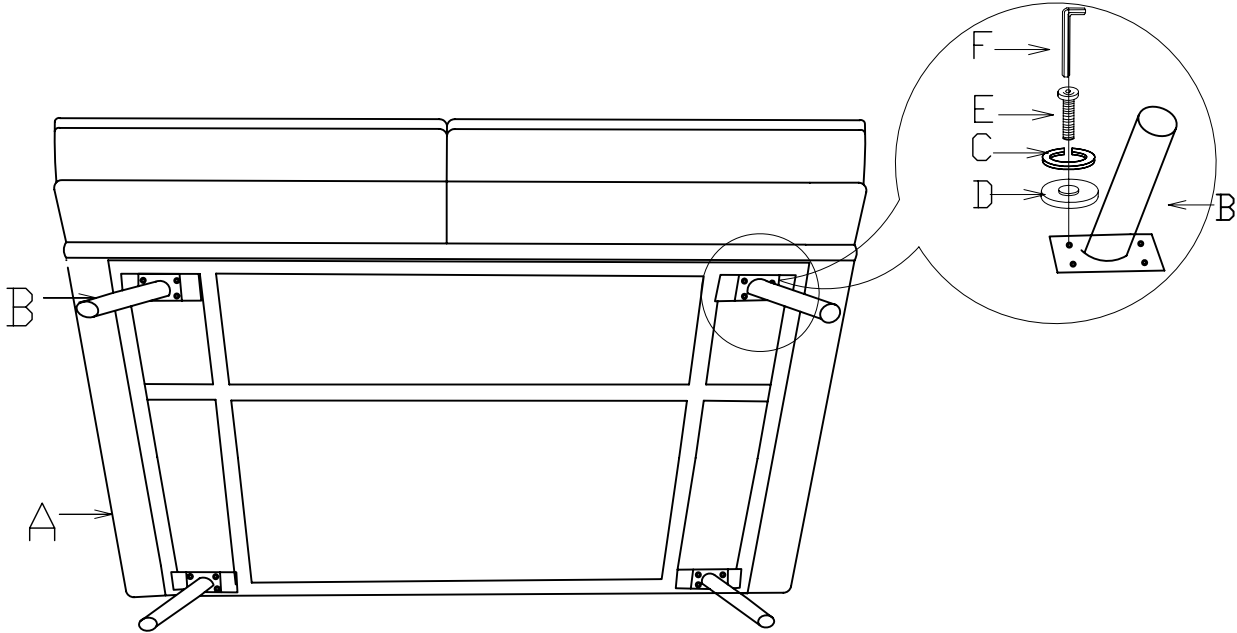

**STEP 2** Can lay the sofa down to be a bed.

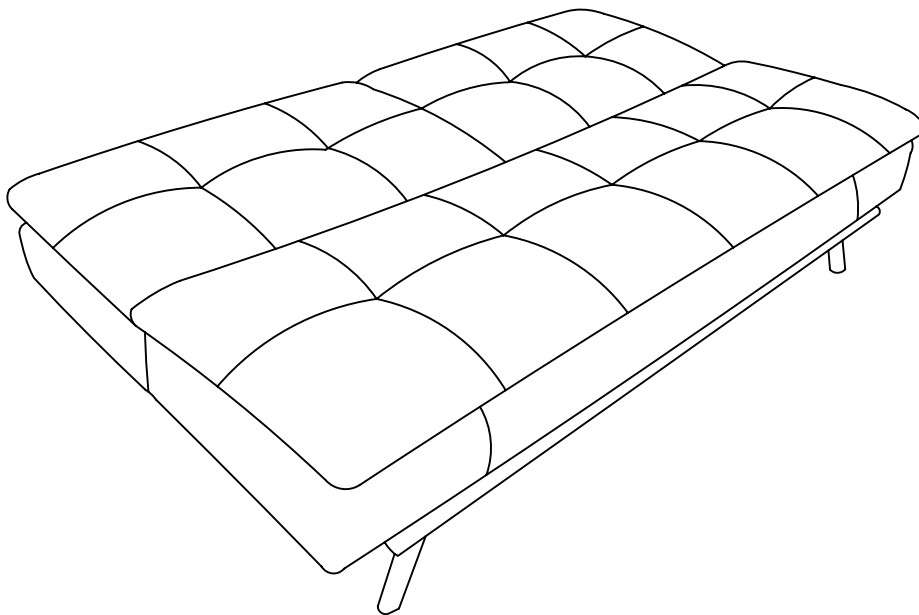

# STEP 3

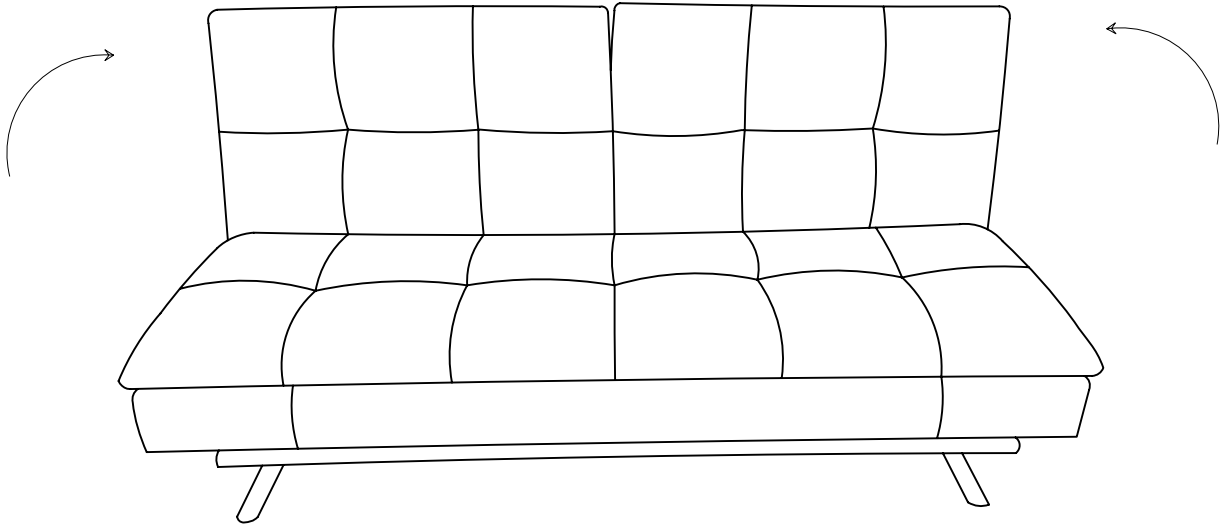

# STEP 4

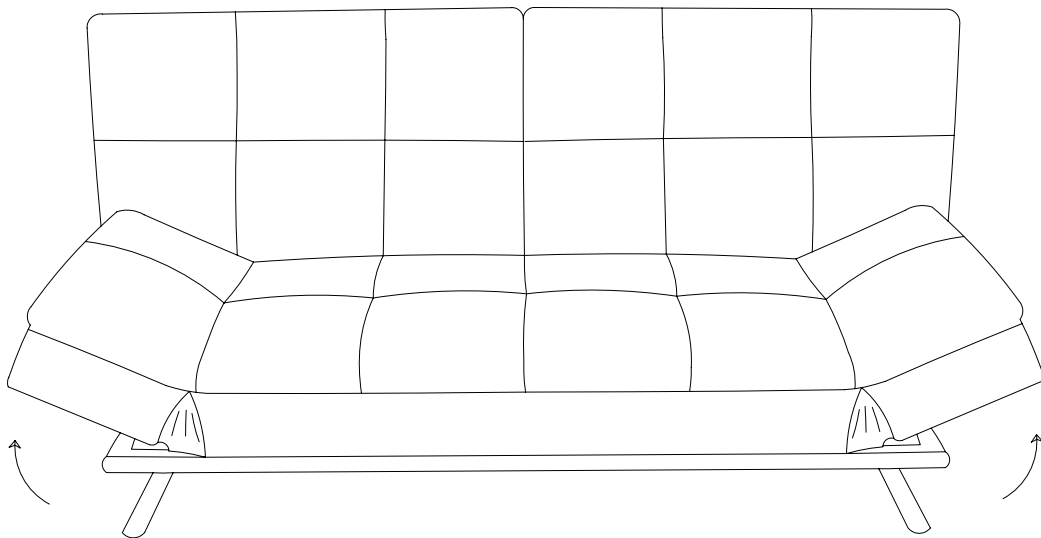

# ASSEMBLY IS COMPLETE

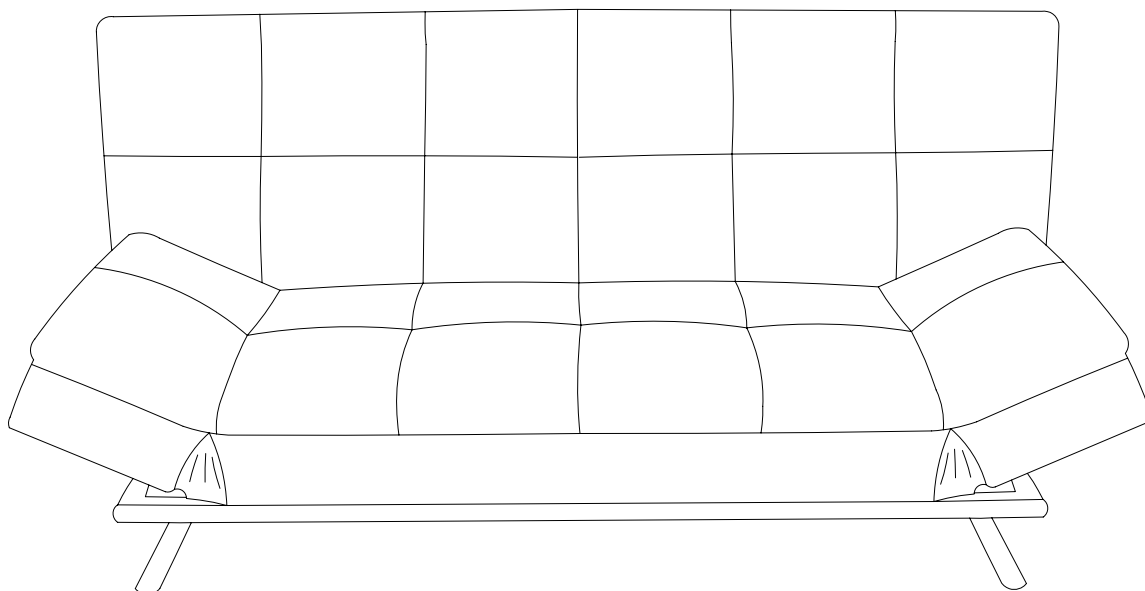

**IMPORTANT: PLEASE ENSURE FEET ARE TIGHTENED SECURELY BEFORE USE!**  
**WARNING-Do not drag lounge on any surface due to timber base, must be lifted.**  
**Two Person Lift Recommended**

# CARE AND MAINTENANCE

## FABRIC CARE

REGULAR CARE: PROTECT FROM DIRECT SUNLIGHT. VACUUM REGULARLY USING LOW SUCTION. ROTATE REVERSIBLE CUSHIONS REGULARLY.

### CLEANING:

DO NOT REMOVE CUSHION COVERS FOR SEPARATE CLEANING EVEN THOUGH THEY HAVE ZIPPERS.

DO NOT WASH

DO NOT DRY CLEAN

DO NOT SHAMPOO

CLEAN CLEAN WITH HOT-WATER EXTRACTION MACHINE. (HOT)

PROFESSIONAL CLEANING RECOMMENDED

DO NOT USE DISHWASHING OR LAUNDRY DETERGENTS

USE ONLY UPHOLSTERY DETERGENTS

DO NOT WET FILLING

DRY IN SHADE AWAY FROM DIRECT HEAT AND SUNLIGHT ALLOW TO

DRY THOROUGHLY BEFORE RE-USE

### SPOT CLEANING:

DO NOT RUB

DO NOT SPOT CLEAN WITH ANY SOLVENT.

TREAT SPILLS AND STAINS AS SOON AS POSSIBLE.

GENTLY SCRAPE ANY SOIL OR MOP ANY LIQUID

FROM THE SURFACE OF THE FABRIC.

APPLY PROPRIETARY CLEANING AGENTS STRICTLY ACCORDING TO INSTRUCTIONS TO REMOVE THE RESIDUE OF THE SPILL.

DO NOT SATURATE THE FABRIC OR INTERIOR WITH WATER OR OTHER CLEANING LIQUIDS.

WARNING: APPLY ONLY WATER-BASED SOIL RESIST (FABRIC PROTECTION) TREATMENTS. DO NOT USE AEROSOL PRODUCTS.