

ASSEMBLY INSTRUCTION

SOLANTO

3 Piece Outdoor Setting

ITEM CODE 82838

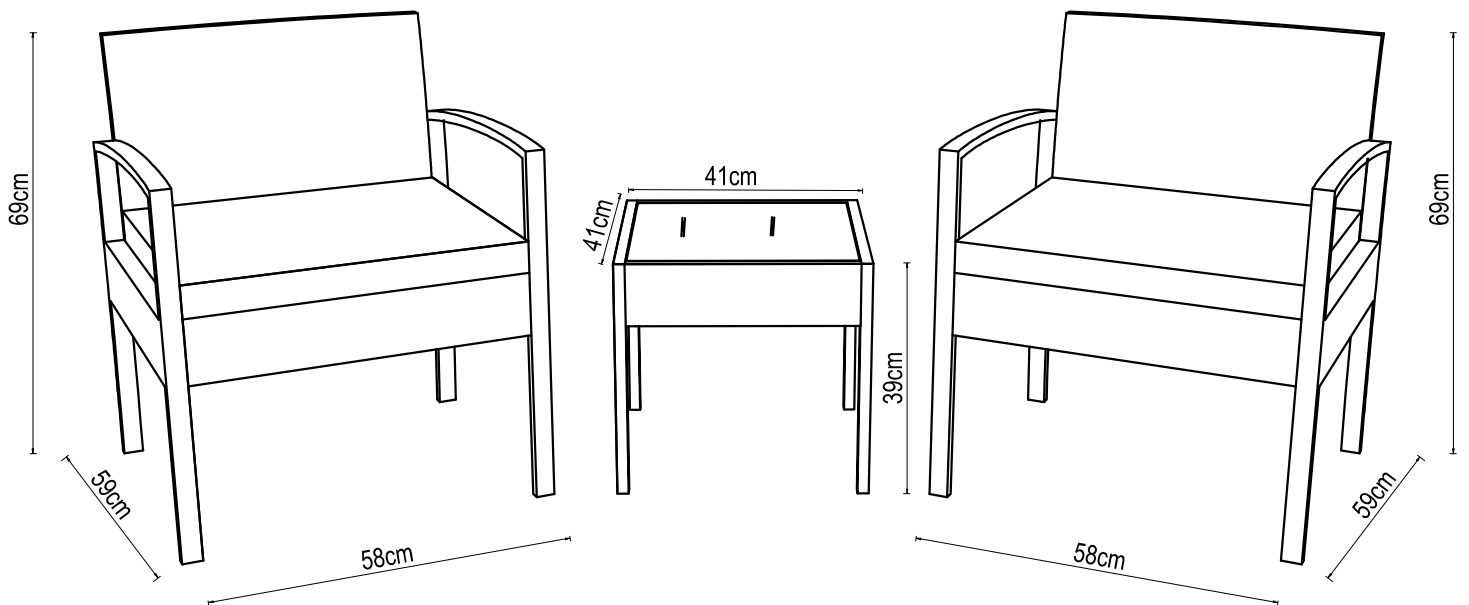



Imported by JWA Furniture Pty Ltd, Brisbane, QLD, Australia
For any assistance with assembly or for missing parts, please refer to your receipt

PRE-ASSEMBLY PREPARATION

Before you start:

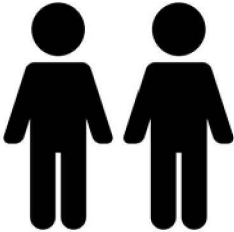
1. Choose a clean, level, spacious assembly area. Avoid hard surfaces that may damage the product.
2. Take care when lifting. Product should be assembled as near as possible to the point of use.
3. Ensure that you have all required contents for complete assembly.
4. Always read the assembly instructions carefully before beginning assembly.
5. Keep all hardware parts and packaging out of reach of small children.
6. Do not over tighten the screws and bolts as this may damage the threads.
7. Assembly is to be carried out by a competent adult(s) ONLY
8. During assembly, children should be kept away from the product due to possible risk to injury.
9. Do not use this item if any components are missing or damaged.
10. Please keep the instructions for future reference.

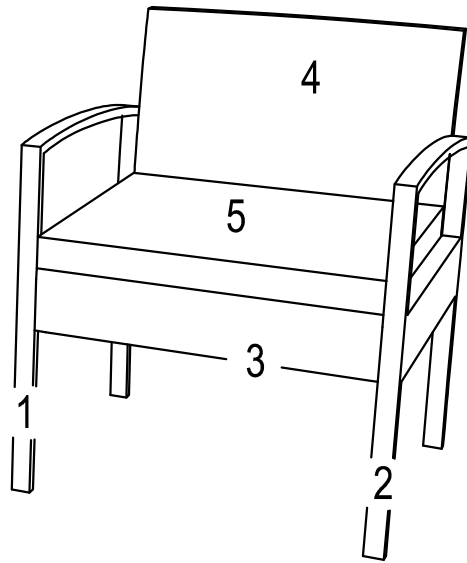

		
Allow 60min	For 2 person	You will need a tape measure.

PARTS LIST



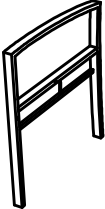
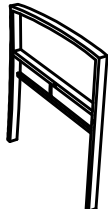
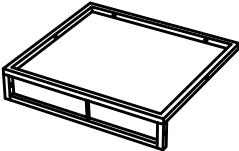
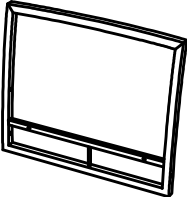
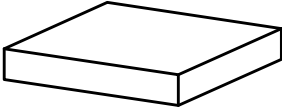
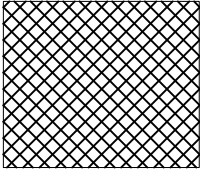

x 2

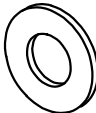
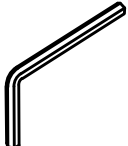
1. Right arm		2PCS	2. Left arm		2PCS
3. Seat		2PCS	4. Backrest		2PCS
5. Seat Cushion		2PCS	6. Non-slip mat		2PCS

A. Bolt	B. Bolt	C. Washer	D. Allen Key
			
M6*30 , 4PCS	M6*40 , 16PCS	M6 , 20PCS	M6 , 1PC

Part A: Single Sofa

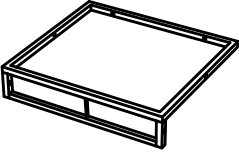
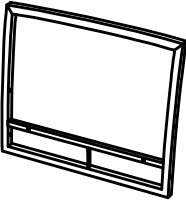
You will need the following

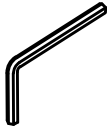
3. Seat 1PC 	4. Backrest 1PC 	
B. Bolt  M6*40*2PCS	C. Washer  M6*2PCS	D. Allen Key  M6*1PC



Step 1:

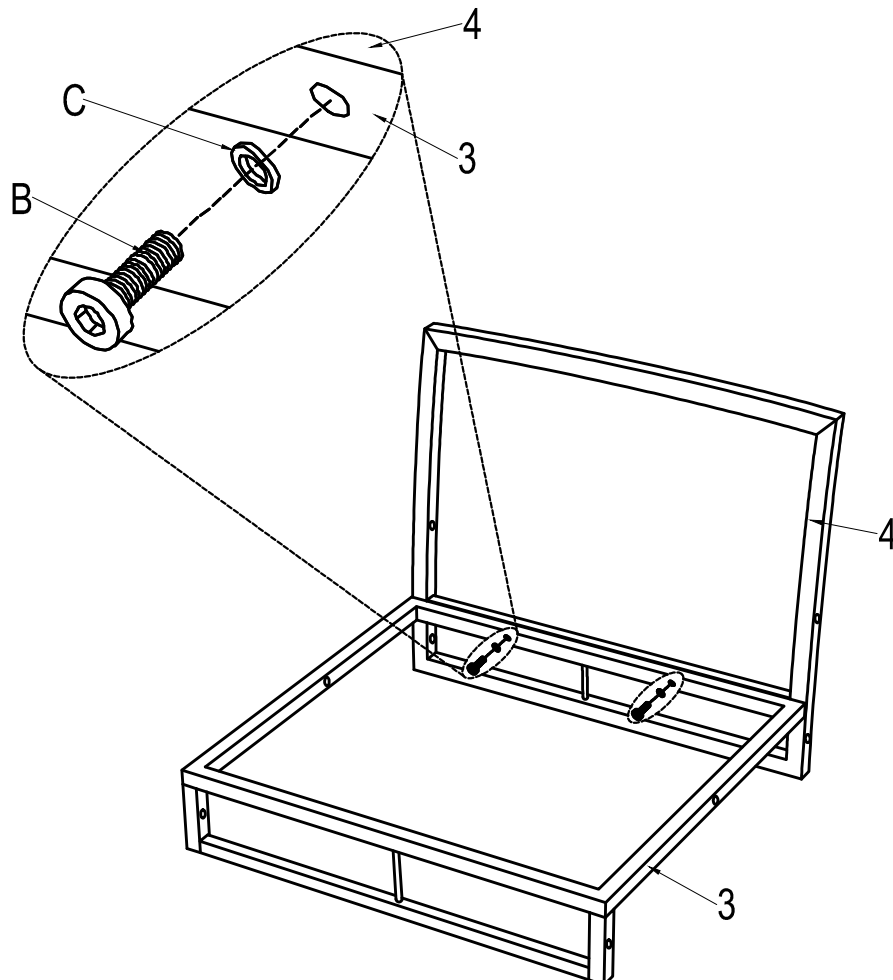

- Attach seat (3) to backrest (4) using bolt (B) with washer (C) .
- Insert all bolts before fully tightening .
- Tighten with allen key (D) .

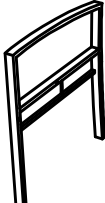

Part A: Single Sofa

You will need the following

1.	Right Arm	1PC	2.	Left Arm	1PC
					

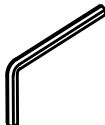
A.	Bolt	B.	Bolt	C.	Washer	D.	Allen Key
							
M6*30*2PCS		M6*40*6PCS		M6*8PCS		M6*1PC	

Step 2:

- Attach backrest (4) and seat (3) to right arm (1) and left arm (2) using bolt (A) and bolt (B) with washer (C) .
- Insert all bolts before fully tightening .
- Tighten with allen key (D) .

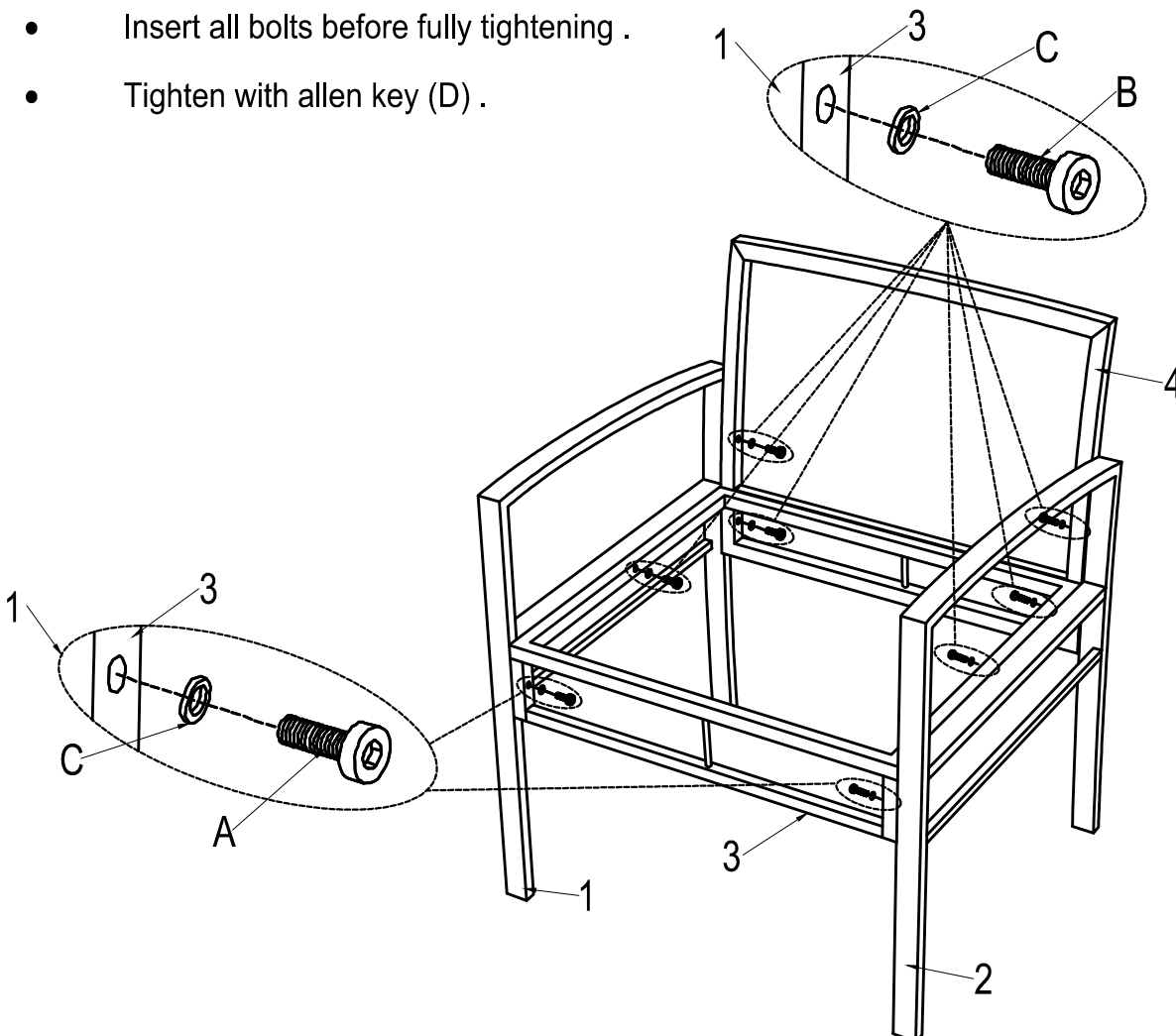

Part A:Single Sofa

You will need the following

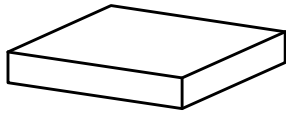
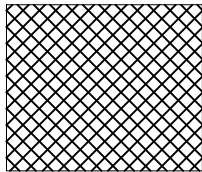
5.	Seat Cushion	1PC	6.	Non-slip mat	1PC
					

Step 3:

- Put the seat cushion (5) on the non-slip mat (6).

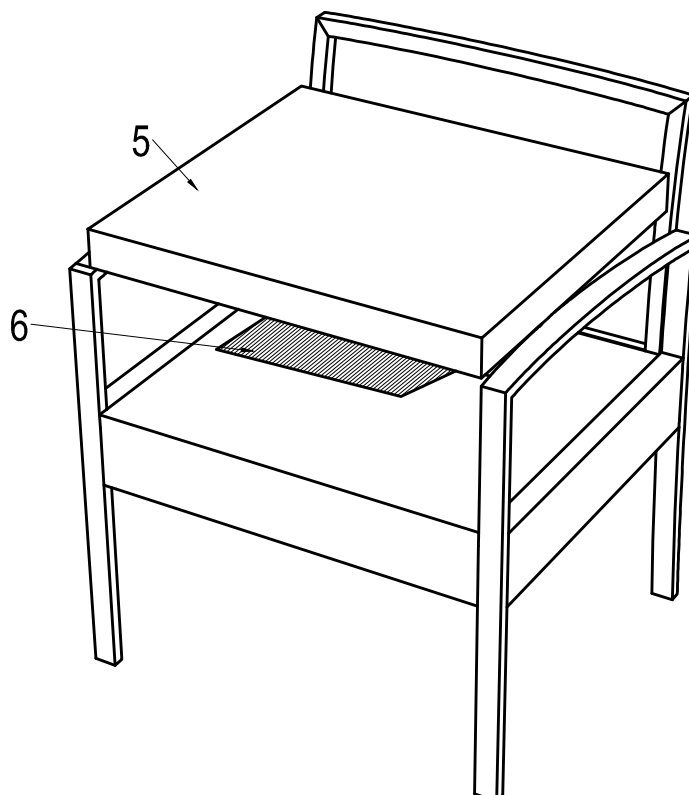

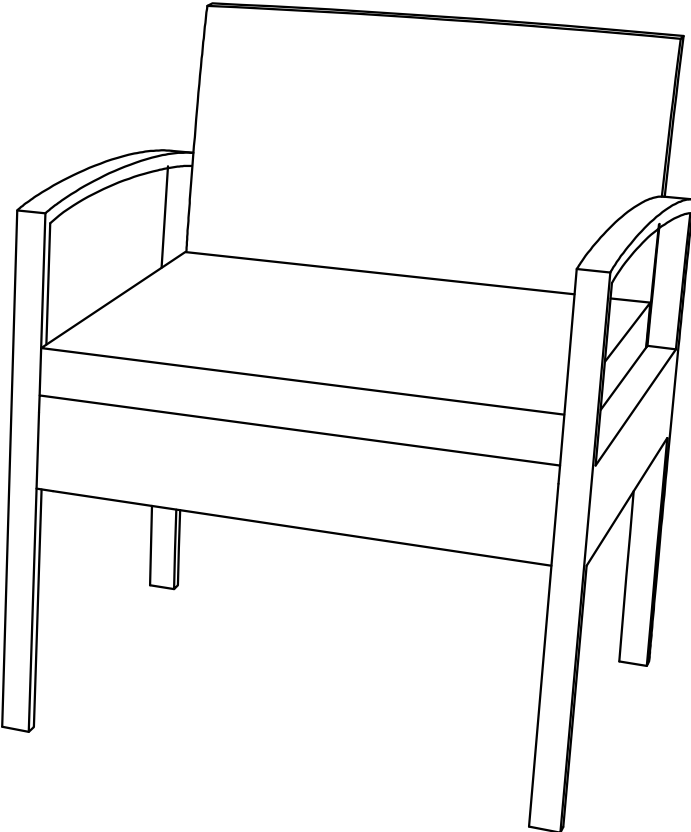
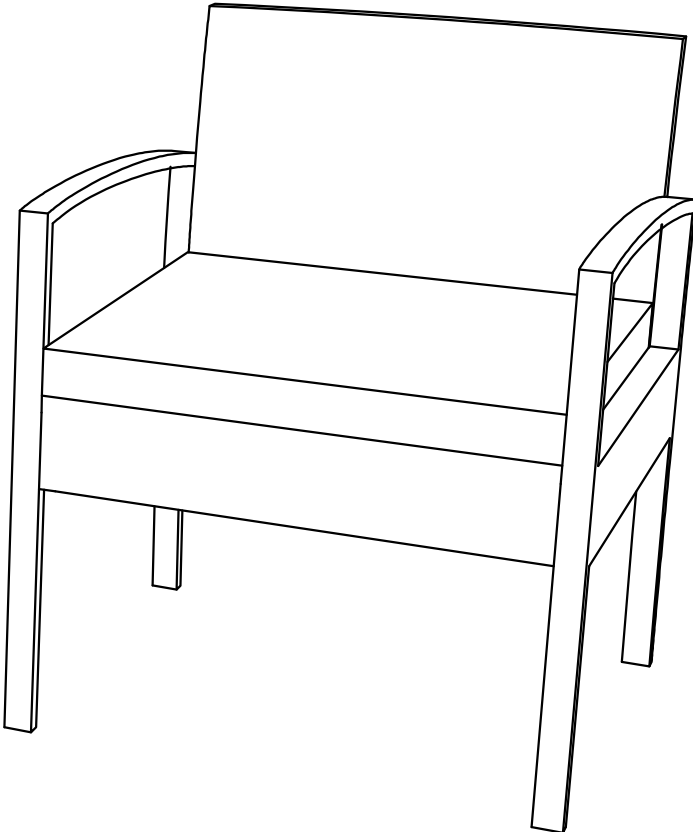

ASSEMBLY IS COMPLETE

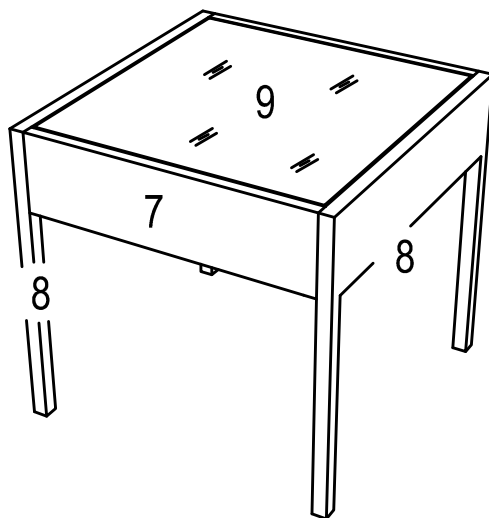

PARTS LIST

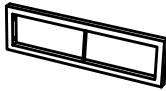
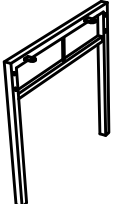

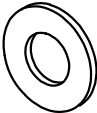
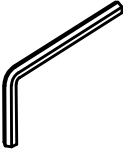

<p>7. Fixed Link 2PCS</p> 	<p>8. Legs 2PCS</p> 
<p>9. Glass 1PC</p> 	

<p>E. Bolt</p>  <p>M6*28 , 8PCS</p>	<p>C. Bolt</p>  <p>M6 , 8PCS</p>	<p>D. Allen Key</p>  <p>M6 , 1PC</p>
--	---	--

Part B: Coffee Table

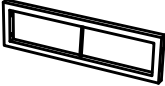
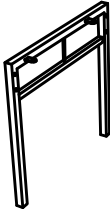
You will need the following

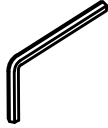
7. Fixed Link 2PCS 	8. Legs 2PCS 	
E. Bolt M6*28*8PCS 	C. Washer M6*8PCS 	D. Allen Key M6*1PC 

Step 1:

- Attach legs (8) to fixed link (7) using bolt (E) with washer (C) .
- Insert all bolts before fully tightening .
- Tighten with allen key (D) .

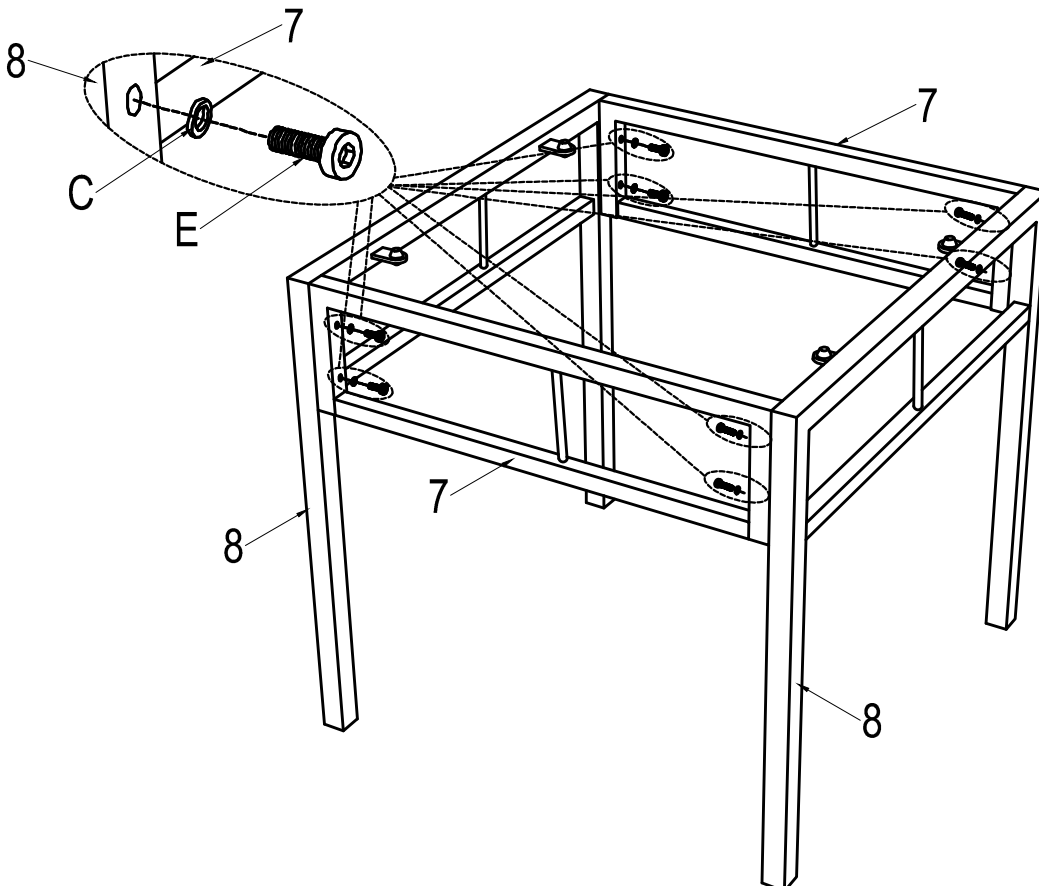

Part B: Coffee Table

You will need the following

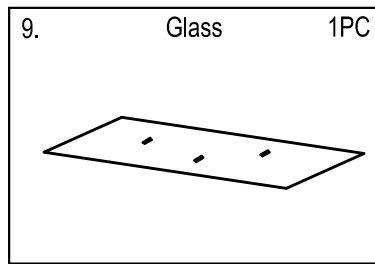

Step 3:

- Turn over the table frame.
- Place glass (9) on the top of the table.
- Glass is secured on the table with suckers.

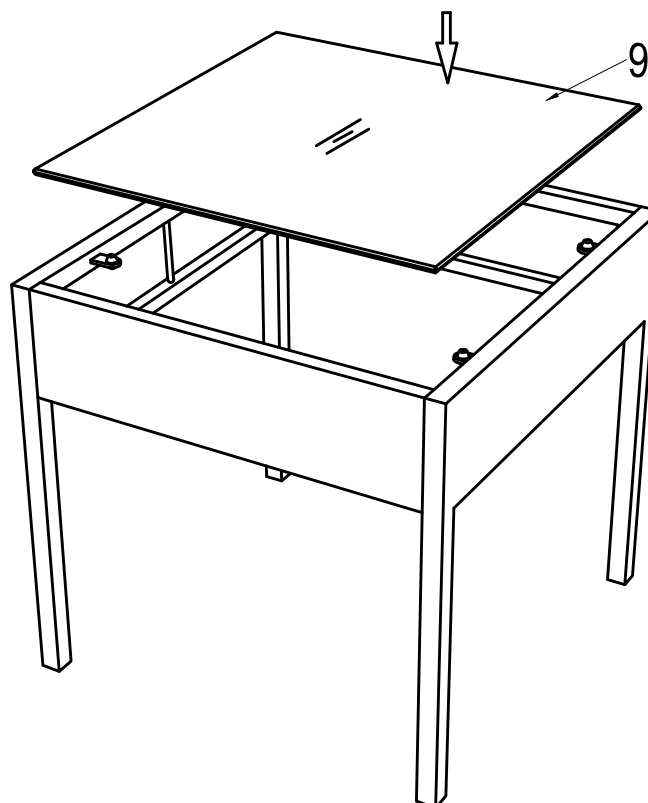

PRODUCT CARE:

Metal

- ☒ Item is designed for use outdoors. However we do not recommend leaving this product outside when not in use. To preserve the life of this item, avoid prolonged exposure to the elements & store inside/under cover or use an outdoor cover.
- ☒ DO NOT allow the furniture to be left in the rain or left wet for extended periods of time.
- ☒ Wipe furniture Dry immediately after it becoming wet.
- ☒ DO NOT clean your furniture down with any harsh solvents, abrasives or chemicals.
- ☒ To remove dirt and grime, simply rinse with fresh water or periodically clean using a sponge and mild detergent solution as required

Cushions

- ☒ Direct exposure to the Sun's harmful UV rays is likely to cause rapid colour fading to fabrics. For best results we recommend avoiding exposure to direct sunlight
- ☒ To ensure product longevity it is recommended outdoor products are not left permanently exposed to the elements
- ☒ Spot clean using mild detergent and damp cloth. Dry flat in shade
- ☒ Do not unzip
- ☒ Do not put in washing machine
- ☒ Do not tumble dry
- ☒ Do not bleach
- ☒ Do not dry clean
- ☒ Cool iron only

Glass

- ☒ If the glass is chipped or broken, stop using the product and consult place of purchase .
- ☒ Do not drop, drag or strike glass .
- ☒ Do not sit or stand upon the glass surface .
- ☒ Do not place very hot or cold items on the glass surface unless adequately thick table mats are used to prevent such items coming in contact with the glass .
- ☒ Do not place heavy objects on glass .
- ☒ Avoid scratching the glass or using as a chopping surface .
- ☒ Do not strike the glass with hard or pointed items .
- ☒ When cleaning the glass panels use a damp cloth with washing up liquid or soft soap if necessary. Do not use washing powders or any other substances containing abrasives since these may scratch the glass.

PRODUCT CARE:

Outdoor Wicker Furniture Care Instructions:

- **What is Wicker?**

- Wicker is a weaving technique used to create outdoor furniture, baskets, and decorative items. It involves weaving thin, flexible strands of materials like rattan, bamboo, or synthetic materials to form intricate patterns. Wicker furniture is known for its natural beauty and durability, making it a popular choice for outdoor spaces. In this guide, we'll share care instructions to help you maintain the appeal and longevity of your wicker outdoor furniture.

- **Regular Cleaning:**

1. **Frequency:** Every 4-6 weeks, clean your outdoor wicker furniture to maintain its appearance and longevity.
2. **Cleaning Solution:** Use a mild detergent mixed with warm water for cleaning.
3. **Washing:** Gently wash the furniture with the detergent solution, paying attention to intricate woven areas. Use a soft cloth or a soft brush to remove dirt and debris.
4. **Rinse:** Thoroughly rinse the furniture with clean water to remove any soap residue.
5. **Drying:** Ensure the furniture is dried thoroughly after cleaning to prevent oxidization. Let it air dry completely in a well-ventilated area, preferably in indirect sunlight.
6. **Dust Regularly:** Dust your furniture regularly with a soft brush or vacuum cleaner with a brush attachment to prevent dust buildup, which can damage the surface.

- **Seasonal Maintenance:**

1. **Sunlight Exposure:** Avoid leaving your furniture uncovered in direct sunlight for extended periods, as prolonged exposure can cause fading and material deterioration.
2. **Cushion Care:** Remove cushions from the furniture and store them in a covered or undercover area when the furniture is not in use. This helps protect the cushions from the elements.
3. **Weather Protection:** Amart always recommends the use of an outdoor protective cove for your outdoor wicker furniture when not in use. Ensure the covers are clean and completely dry before use to prevent mold and mildew growth. Even when your wicker furniture is under a patio or awning, Amart still recommends the use of cover – to prevent fading or sun damage.

By following these instructions, you can maintain the longevity and appearance of your outdoor wicker furniture.