

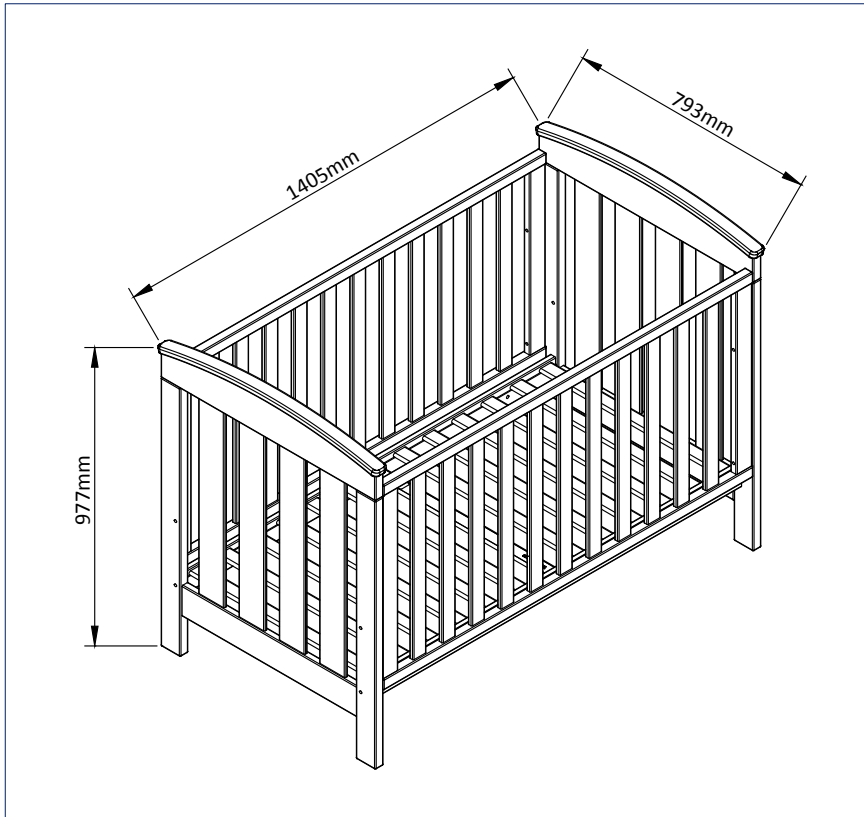

ASSEMBLY INSTRUCTION  
MAHALIA COT  
ITEM CODE 76318

Imported by Amart Furniture Pty Ltd, Brisbane, QLD Australia.  
For any assistance with assembly or for missing parts please phone  
Amart Furniture, Customer Service Free call 1800 351 084



Imported by Amart Furniture Pty Ltd, Brisbane QLD Australia.  
For any assistance with assembly or for missing parts please phone  
Amart Furniture, Customer Service Free call 1800 351 084

# PRE-ASSEMBLY PREPARATION

## Before you start:

1. Choose a clean, level, spacious assembly area. Avoid hard surfaces that may damage the product
2. Take care when lifting. Product should be assembled as near as possible to the point of use
3. Ensure that you have all required contents for complete assembly
4. Always read the assembly instructions carefully before beginning assembly.
5. Keep all hardware parts and packaging out of reach of small children.
6. Do not over tighten the screws and bolts as this may damage the threads

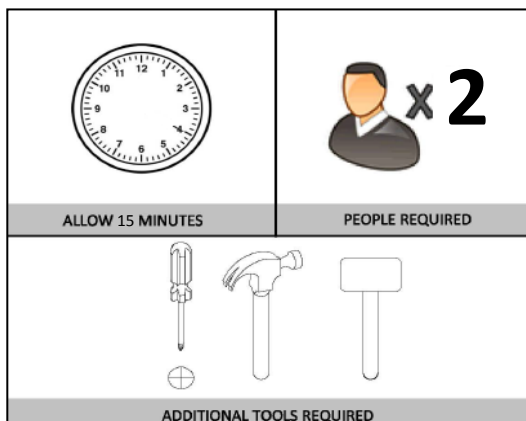

## Safety notes

NOTE: Use only spare parts approved by the manufacturer

FOR AUSTRALIA AND NEW ZEALAND (AS/NZS 2172:2013)

RECOMMENDED MATTRESS SIZE 1320mm X 700mm X 120mm

This cot has been manufactured for use with a mattress which measures 700mm wide by 1320mm long and 120 mm in thickness . The width and length are specified because it is important that the gaps between the mattress and the sides and ends of the cot will not exceed 40mm when the mattress is pushed to one side or end , and 20 mm when the mattress is centred in the cot . This is to minimize the risk of a child's limb becoming caught in the gap. The thickness of the mattress has been specified to ensure that the depth of the cot is greater than 500 mm with the mattress base in the lower position to minimise the risk of a child climbing or falling out of the cot.

### WARNING:



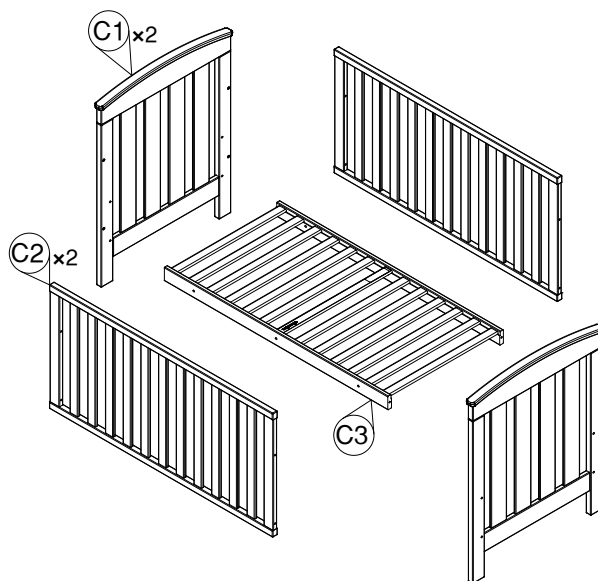

- \* TO ENSURE THE SAFETY OF YOUR COT,REGULARLY CHECK ALL THE CONNECTING BOLTS AND GLIDE PINS MAKING SURE THEY ARE TIGHT.
- \* TO PREVENT FALLS OR SUFFOCATION THE MAXIMUM MATTRESS THICKNESS SHOULD NOT EXCEED 120MM
- \*WARNING: TO PREVENT FALLS, THE MATTRESS BASE OF THIS COT SHOULD BE ADJUSTED TO THE LOWEST POSITION BEFORE THE CHILD CAN SIT UP.
- \* Follow the manufacturer's assembly instructions in detail to ensure the safety features of the cot are not compromised.
- \* Ensure the cot is placed at a reasonable distance from curtains, blinds, heaters and power points.
- \* Keep cot free of any toys, cushions etc that could be used as a foothold or present a danger of suffocation or strangulation.
- \* Keep medication, String, elastic or small items such as money out of reach from any position in the cot.

## EXPLODED VIEW

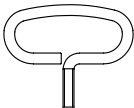

C1	2	977×793×46mm
C2	2	1330×638×29mm
C3	1	1330×688×70mm

## PARTS LIST

<p><b>A</b> <input type="checkbox"/></p>  <p>M4,65×25mm    A×1</p>	<p><b>B</b> <input type="checkbox"/></p>  <p>M4,50×43mm    B×1</p>	<p><b>C</b> <input type="checkbox"/></p>  <p>M6×70mm    C×12</p>
<p><b>D</b> <input type="checkbox"/></p>  <p>M6×23mm    D×4</p>	<p><b>E</b> <input type="checkbox"/></p>  <p>M6×13mm    E×4</p>	<p><b>F</b> <input type="checkbox"/></p>  <p>M6×14mm    F×4</p>

# STEP 1: Do not tighten the bolts for now.

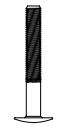
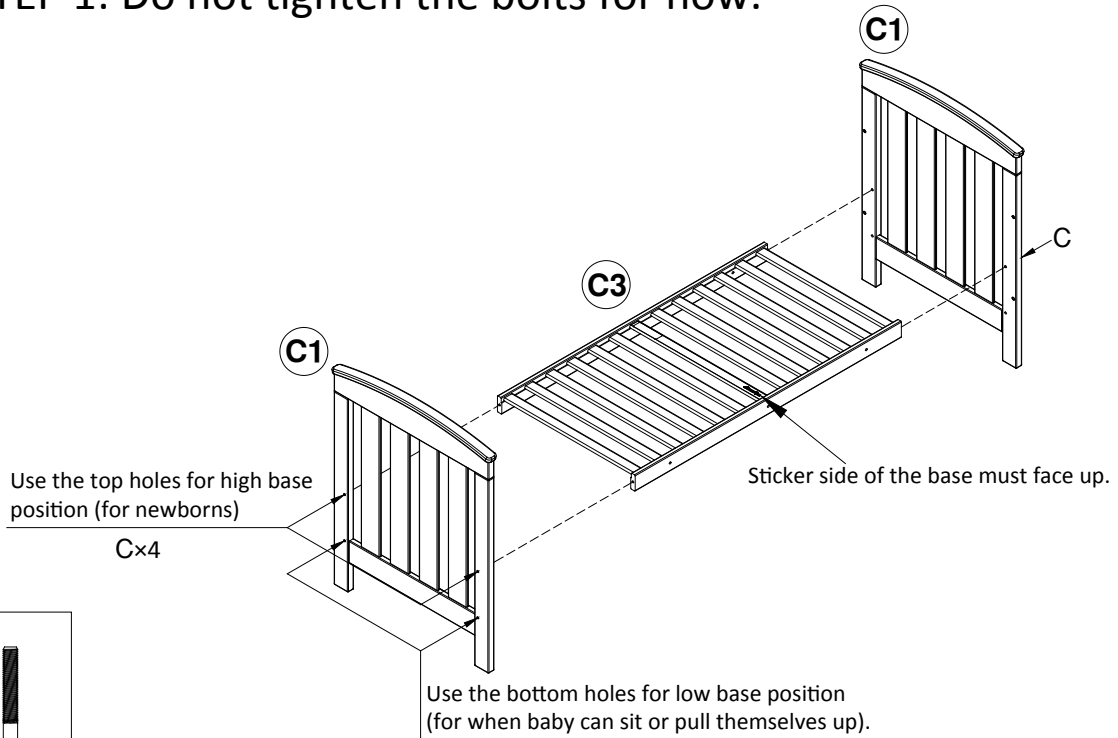

Cx4

# STEP 2: Tighten all the connecting bolts.

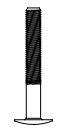
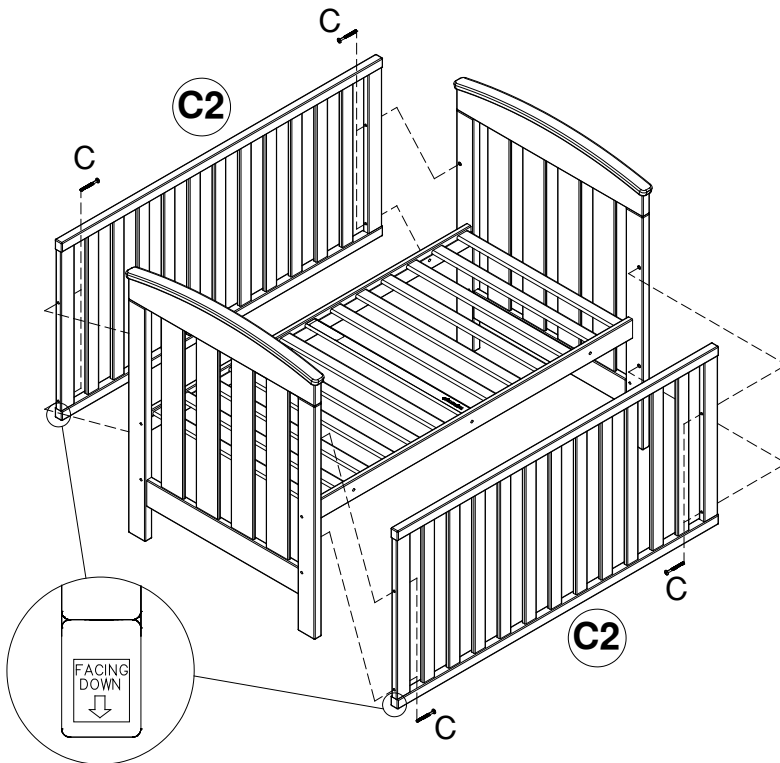

Cx8

STEP 3: Please insert bolts into remaining holes as illustrated to avoid little fingers getting stuck.

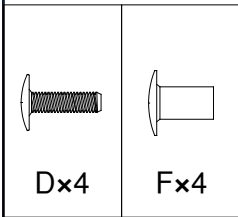
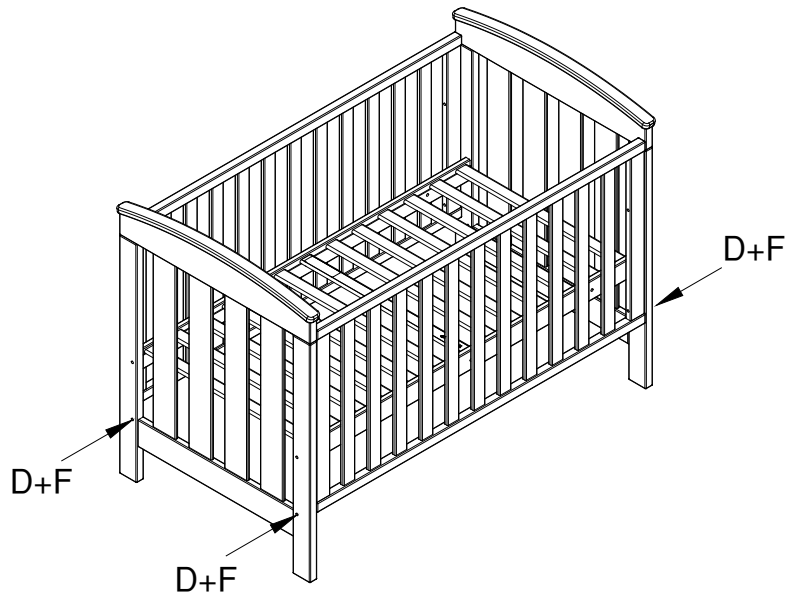

STEP 4: Base should be in the lower position before child is able to sit up or pull themselves up.

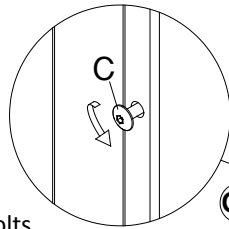

Loosen all blocking bolts on the Side Panels **C2** as shown.

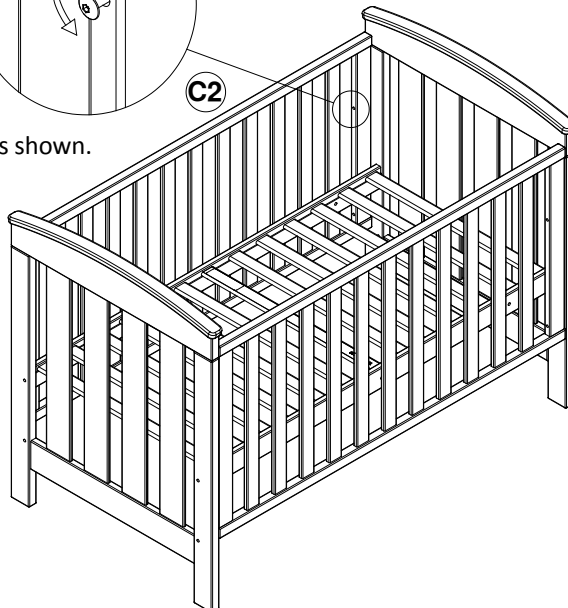

STEP 5:

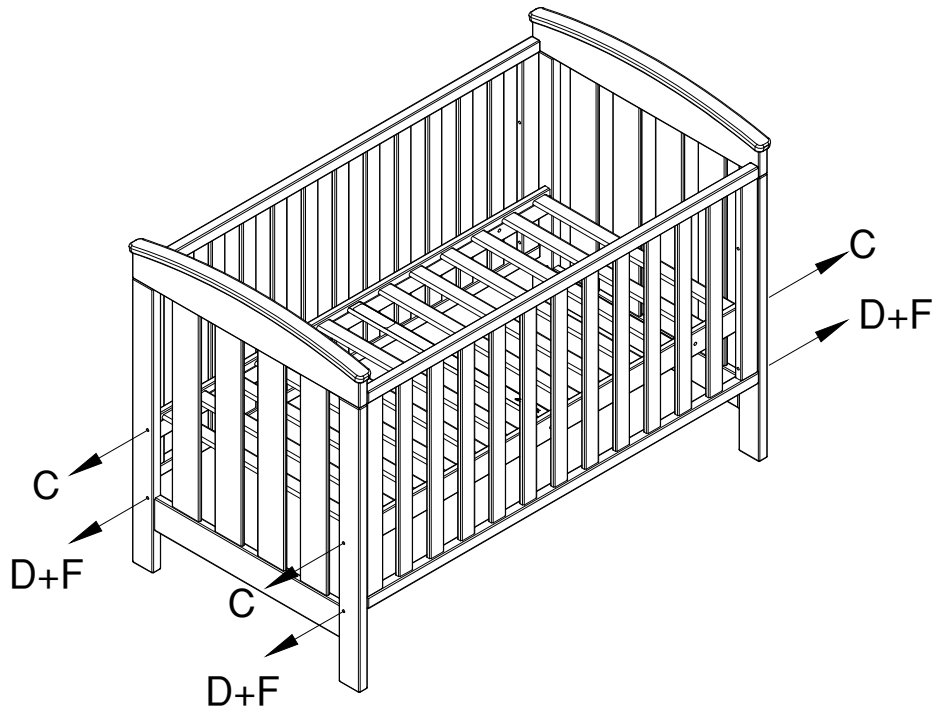

STEP 6:

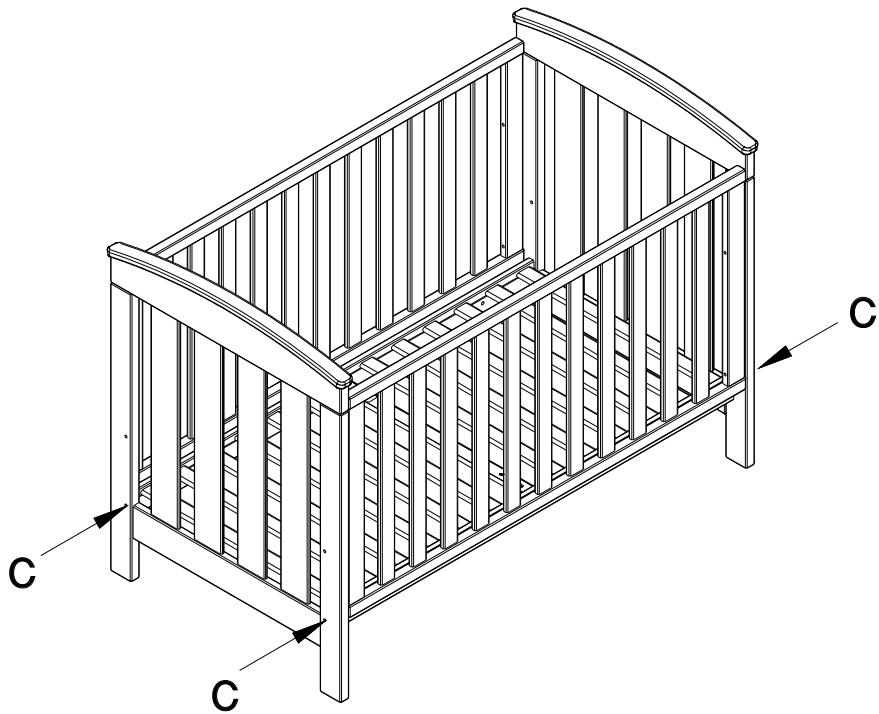

**STEP 7:** Please insert bolts into remaining holes as illustrated to avoid little fingers getting stuck.

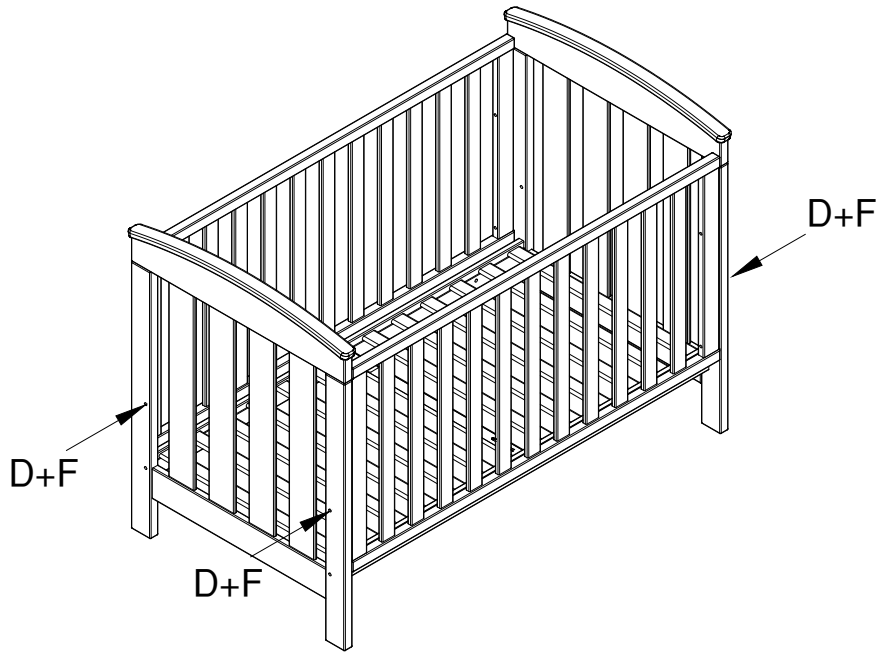

## CONVERT YOUR COT TO TODDLER BED

**STEP 1:**

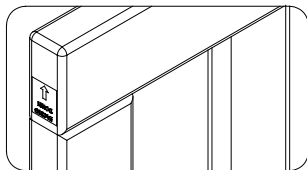

When changed into a toddler bed, this label must be on the top side of the cot

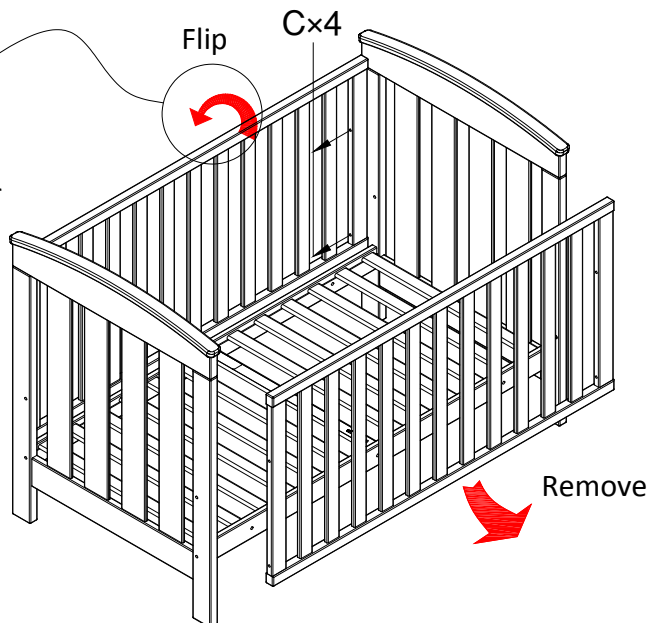

**STEP 2:**

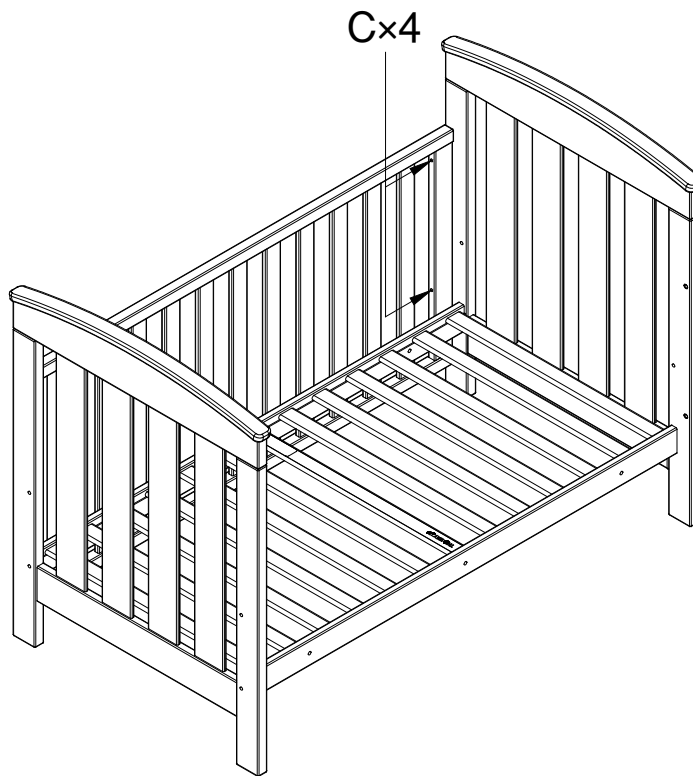

**STEP 3:** Please insert bolts into remaining holes as illustrated to avoid little fingers getting stuck.

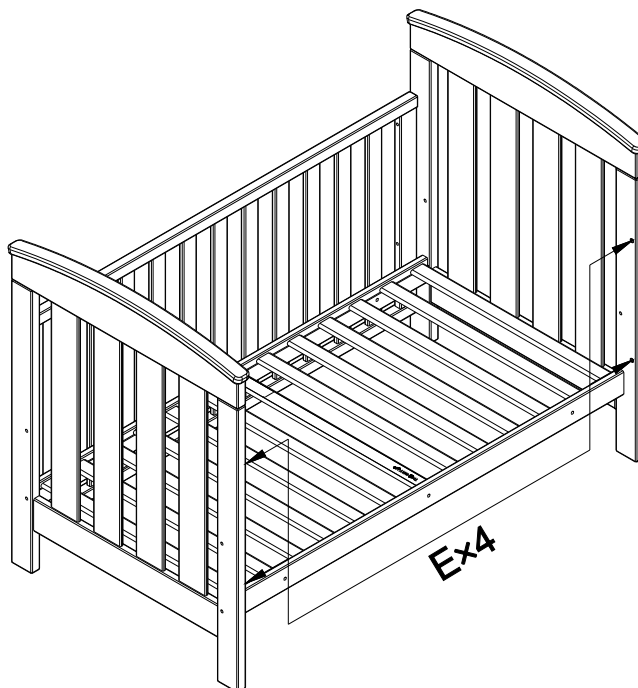

**E×4**





# Warranty against defects

---

**For Australia only** (updated 10/15/2022)

**Amart Furniture Pty Ltd**

41 Brickworks Place, Rochedale QLD 4123 Australia

[www.amartfurniture.com.au](http://www.amartfurniture.com.au)

Customer Service Free call 1800 351 084

ABN: 65 009 810 324

## Care Instructions

Congratulations and thank you for choosing Amart product(s). The furniture you have purchased is constructed from high quality materials for strength and durability. Here are some tips on how you can preserve its beauty for a long time.

1. Do not expose furniture to strong sunlight, direct heat sources, extreme changes in temperature or moisture.
2. Wipe up spills immediately with a soft, clean cloth.
3. Urine spills on furniture can cause discolouration.
4. Clean furniture by wiping the surface with a soft cloth dampened with water.
5. If necessary clean furniture using a mild soap solution and wipe clean with a soft cloth dampened with water and then dry with soft clean cloth.
6. Do not use strong household cleaners.
7. Always wipe in the direction of the grain in the wood do not wipe in a circular motion.
8. Avoid contact with sharp objects, or containers containing hot liquid.
9. Avoid contact with 'rubber feet' on items such as radios, computers, telephones etc. Use a felt mat (not plastic) to protect furniture surfaces.
10. Do not open more than one drawer at a time.
11. When moving furniture do not drag, always lift and place in position.