

ASSEMBLY INSTRUCTION

HOWARD

5 Shelf Wardrobe

ITEM CODE: 83118 / 83138

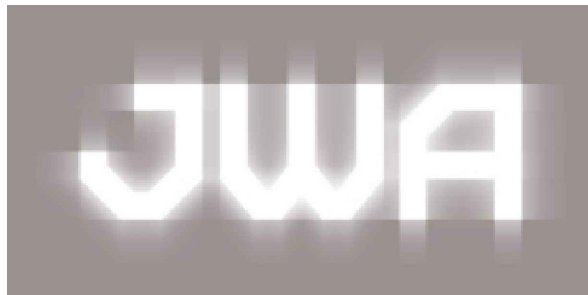
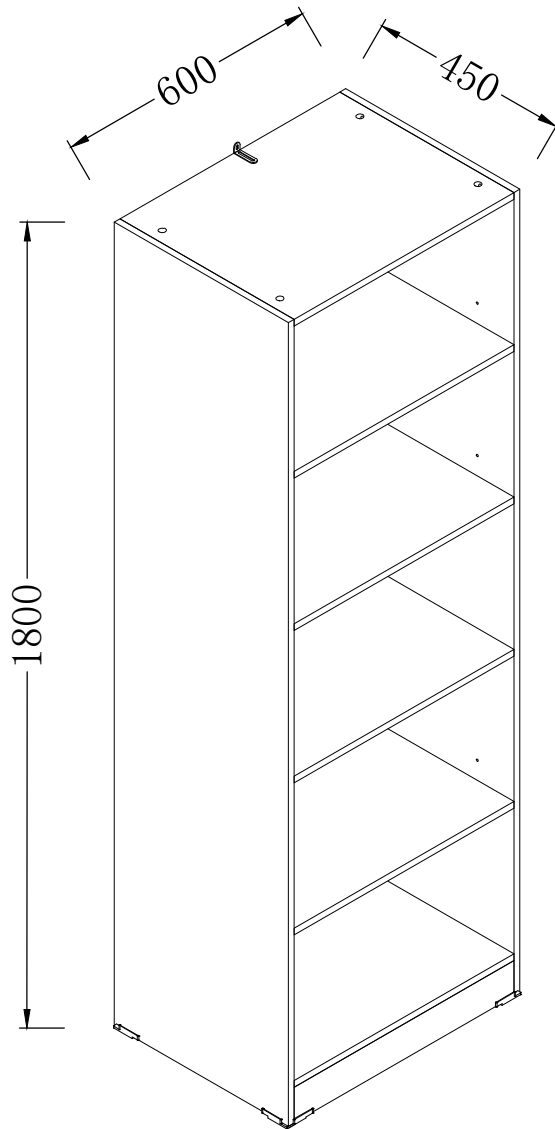







Imported by JWA Furniture Pty Ltd, Brisbane, QLD, Australia
For any assistance with assembly or for missing parts, please refer to your receipt

PRE-ASSEMBLY PREPARATION

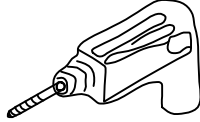
Before you start:

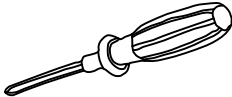
1. Choose a clean, level, spacious assembly area. Avoid hard surfaces that may damage the product.
2. Take care when lifting. Product should be assembled as near as possible to the point of use.
3. Ensure that you have all required contents for complete assembly.
4. Always read the assembly instructions carefully before beginning assembly.
5. Keep all hardware parts and packaging out of reach of small children.
6. Do not over tighten the screws and bolts as this may damage the threads.
7. Assembly is to be carried out by a competent adult(s) ONLY.
8. During assembly, children should be kept away from the product due to possible risk to injury.
9. Do not use this item if any components are missing or damaged.
10. Please keep the instructions for future reference.

		IF REQUIRED 
Allow 60 min	For 1 person	Low speed (Ø6mm)
   ADDITIONAL TOOLS REQUIRED		

WARNING

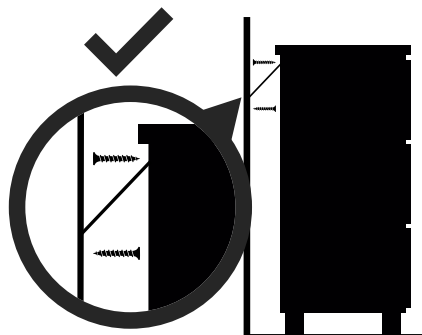

Children have died from furniture tipover.

- ALWAYS secure it with an anchor device.
- NEVER allow children to stand, climb or hang on drawers, doors, or shelves.
- NEVER open more than one drawer at a time.
- Place heavy items down low

NEVER put a TV on this furniture



**This is a permanent label.
Do not remove!**

TO USE CAM LOCK FASTENERS

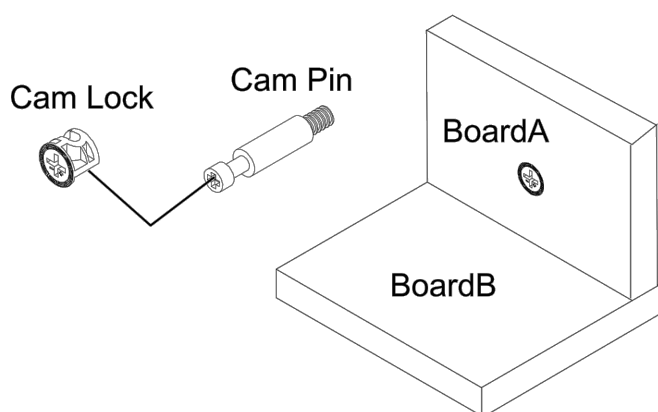

To assemble this product hardware called Cam Lock Fasteners are used. The below is information on how these work. Cam Locks are fasteners used to join two boards together, usually the edge of one board (A) to the flat side of another board (B).

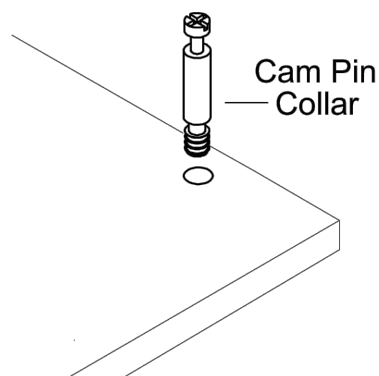

The Cam Pin is inserted into the flat side of a board, it is important that: The cam pin is kept vertical and is not put in on an angle. Cam pin is to be inserted up to collar Too far and it wont catch the Cam Lock (Do Not Overtighten) Not enough and the resulting product will not be stable.

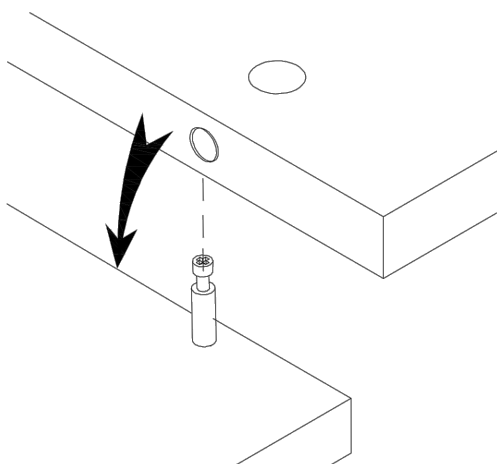

Now fit the hole in the edge of the joining board over the Cam Pin.

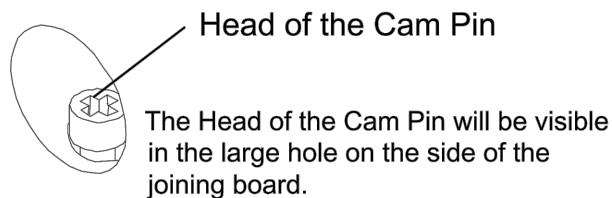

The Head of the Cam Pin will be visible in the large hole on the side of the joining board.

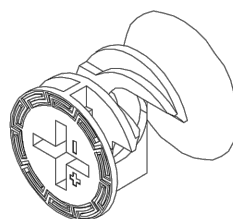

Notice the Cam Lock has a "C" Shaped Back. An arrow or +/- signs on the front indicate the open section on the back of the Cam Pin.

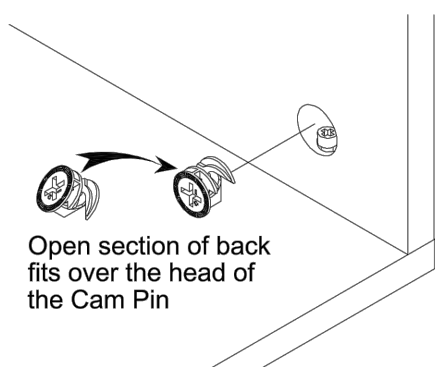



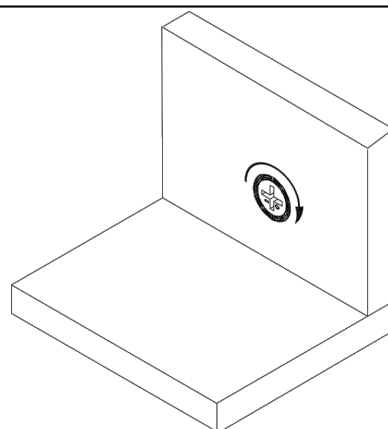



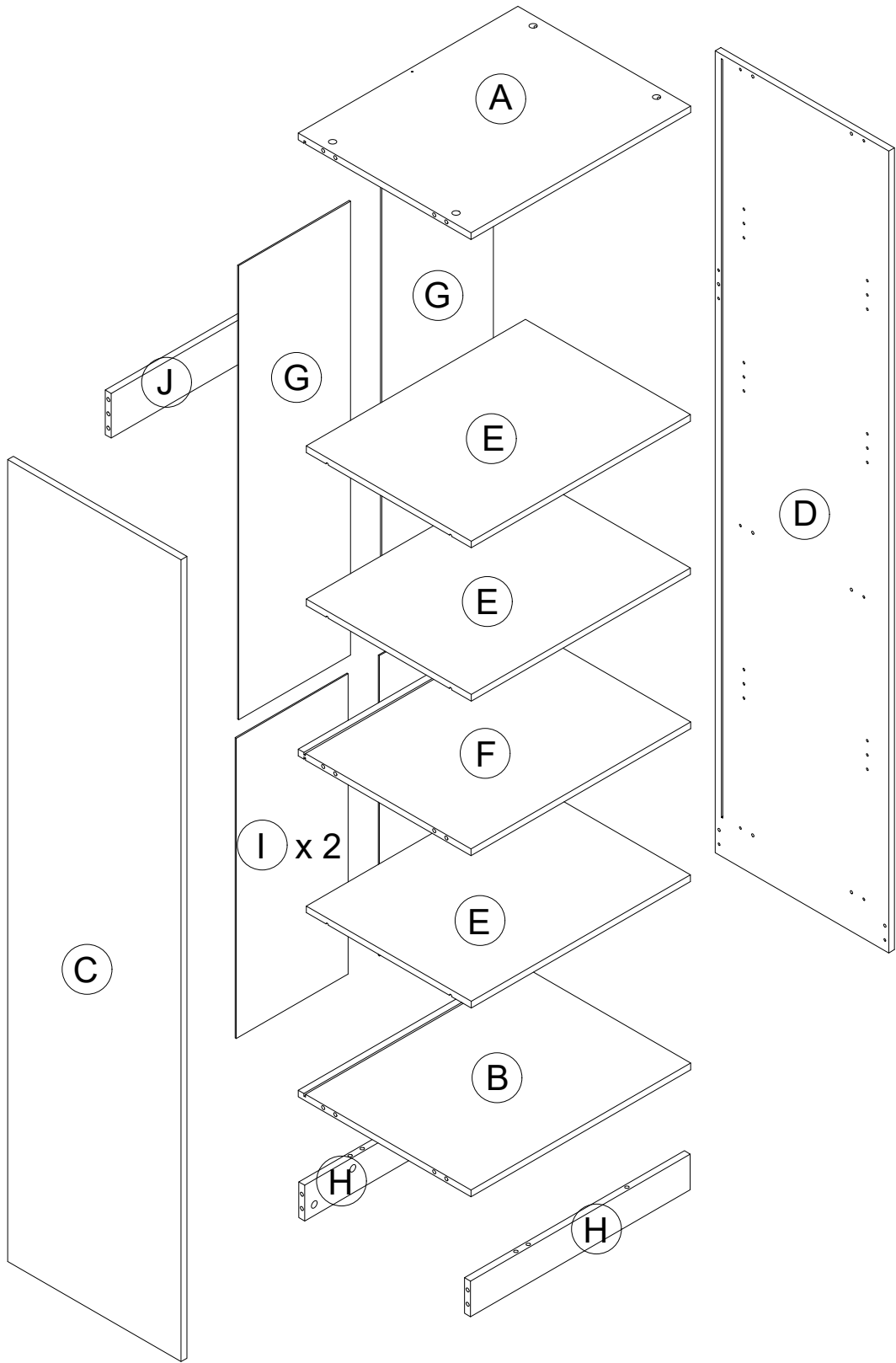

Insert the Cam Lock into the large hole so the opening of the "C" fits over the head of the Cam Pin. You must ensure that the Cam Lock is pushed to the bottom of the hole to catch the top of the Cam Pin.



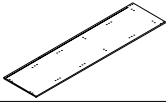
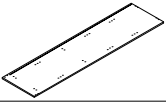











Use a Flat screwdriver to turn the Cam Lock clockwise one half turn so it locks onto the head of the Cam Pin. Turn only until it is snug. Over tightening could cause the Cam to bend or break. If it will not turn the full amount, turn the Cam Pin out (Counter-clockwise) one full turn, and try the Cam Lock again.



Item Code-83118 / 83138

Panel(Mark)	Packing carton	Quantily	Picture	Dimension
A	(BOX 2)	1PC		570 x 448 x 15mm
B	(BOX 2)	1PC		570 x 448 x 15mm
C	(BOX 1)	1PC		1800 x 450 x 15mm
D	(BOX 1)	1PC		1800 x 450 x 15mm
E	(BOX 2)	3PCS		568 x 428 x 15mm
F	(BOX 2)	1PC		570 x 448 x 15mm
G	(BOX 1)	2PCS		1019 x 290 x 3mm
H	(BOX 2)	2PCS		570 x 80 x 15mm
I	(BOX 1)	2PCS		674 x 290 x 3mm
J	(BOX 2)	1PC		570 x 100 x 15mm

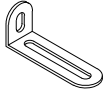
Please note - All Hardwares in box 2 .

<p>① 24 PCS</p>  <p>Ø15 x 12mm</p>	<p>② 24 PCS</p>  <p>Ø6 x 34mm</p>	<p>③ 22 PCS</p>  <p>Ø8 x 30mm</p>	<p>④ 8 PCS</p>  <p>Ø4 x Ø2 x 15mm</p>	<p>⑤ 4 PCS</p>  <p>65 x 65 x 13mm</p>	<p>⑥ 12 PCS</p> 	<p>⑦ 12 PCS</p> 
<p>⑧ 12 PCS</p>  <p>Ø3.5 x 14mm</p>	<p>⑨ 1 PC</p>  <p>Ø9 x Ø4 x 25mm</p>	<p>⑩ 1 PC</p>  <p>Ø9 x Ø4 x 15mm</p>	<p>⑪ 1 PC</p>  <p>20 x 40 x 1.2mm</p>	<p>⑫ 1 PC</p>  <p>Ø9 x Ø6 x 25mm</p>		

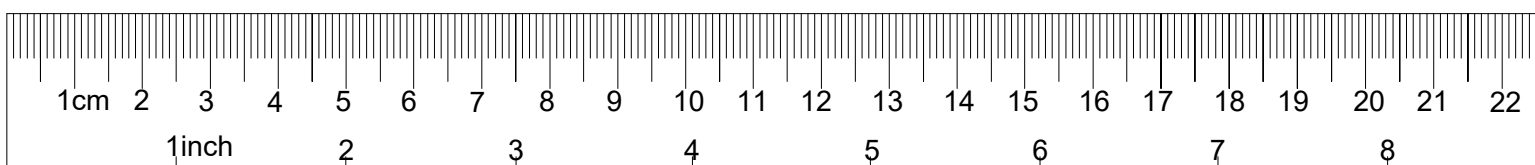

1

 ② x 4

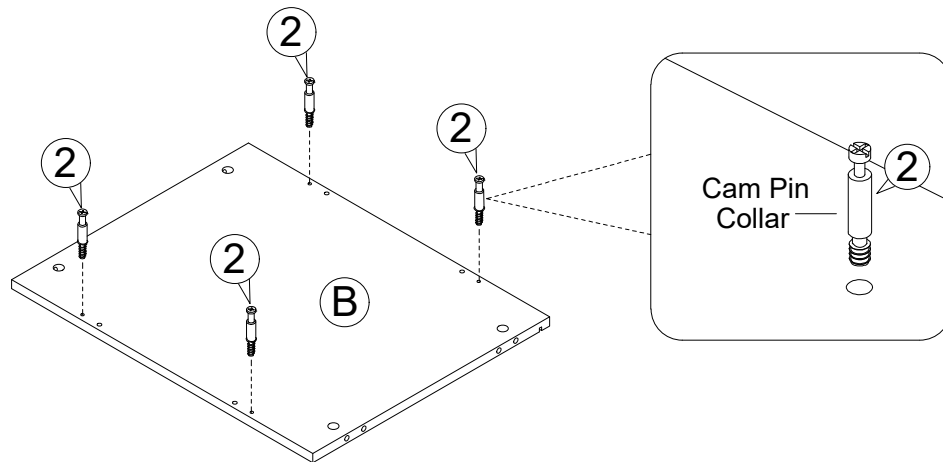

2

 ① x 4

 ③ x 4

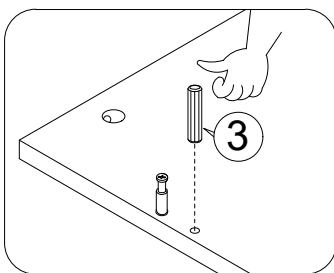
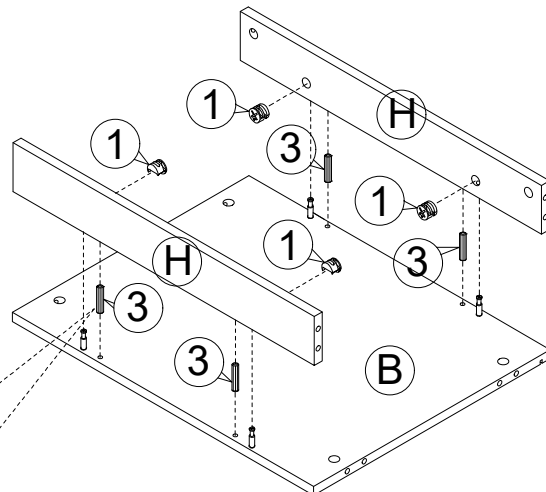

This is how a cam nut works.....

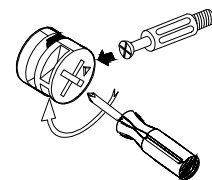

The head of the cam bolt goes into the open mouth of the cam nut. You then turn the cam nut so it tightens over the bolt.

3

 ② x 10

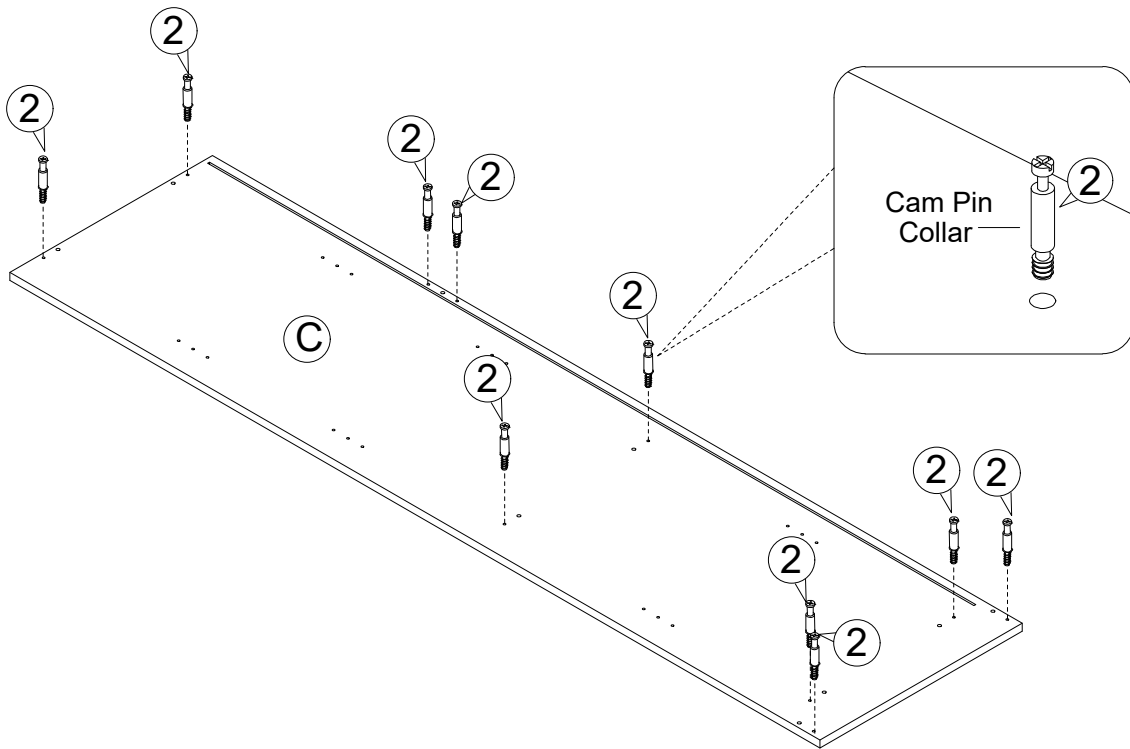
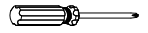

4

 ② x 10

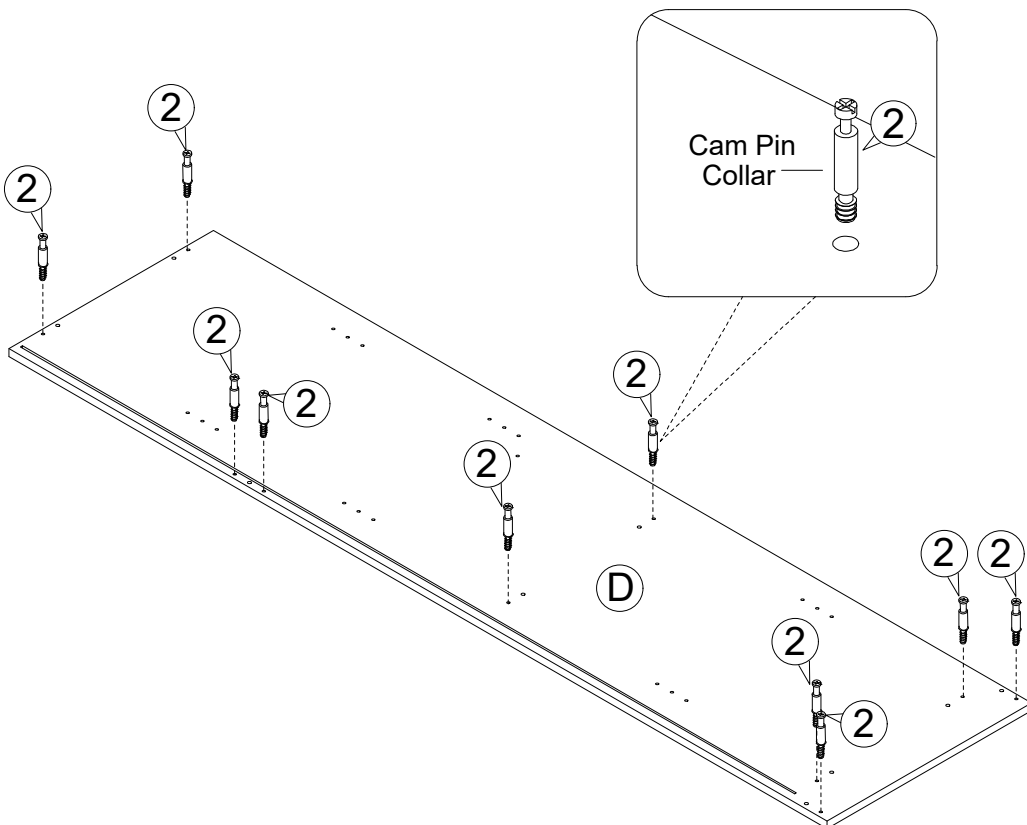
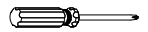

5



① x 10



③ x 9

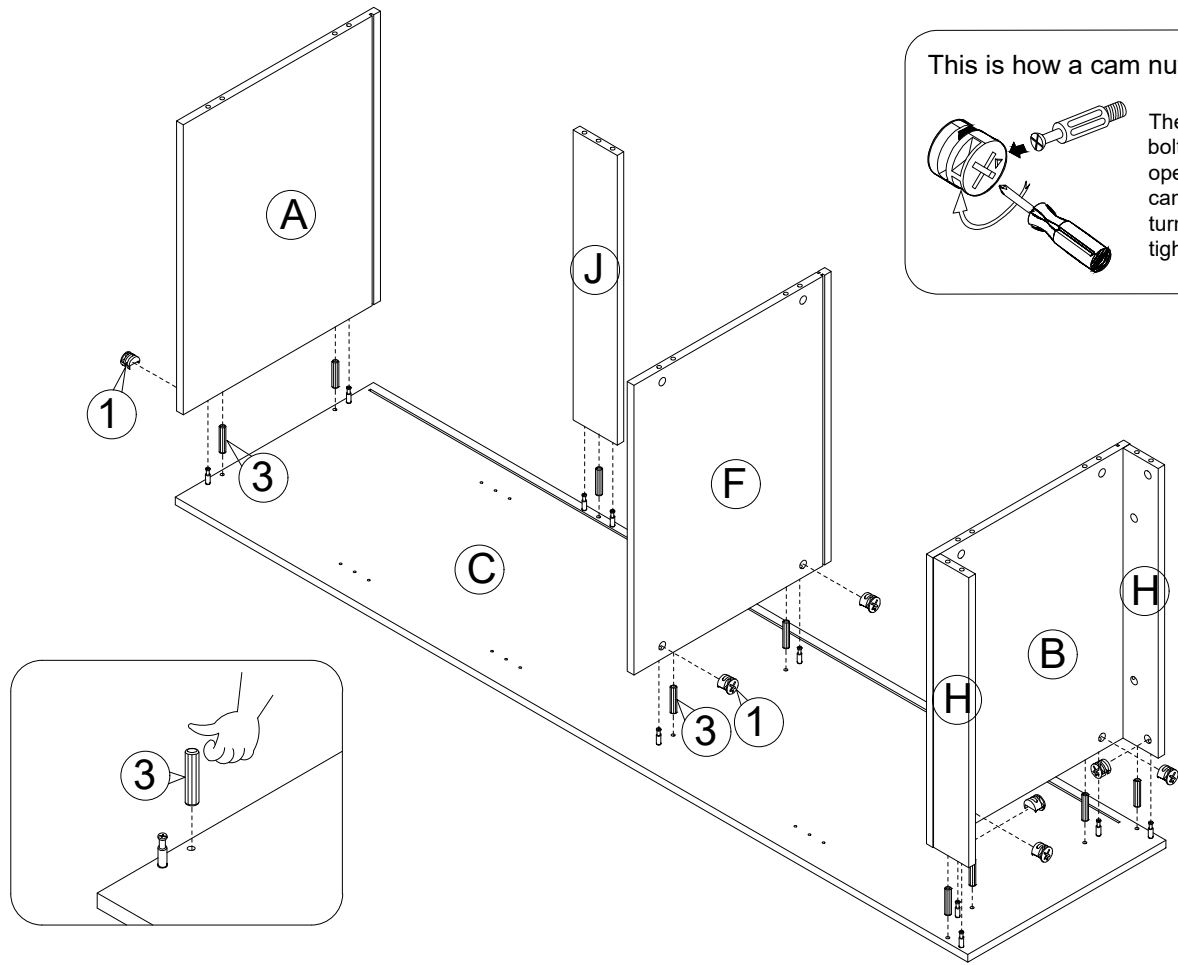

This is how a cam nut works.....

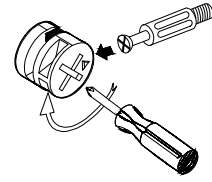

The head of the cam bolt goes into the open mouth of the cam nut. You then turn the cam nut so it tightens over the bolt.

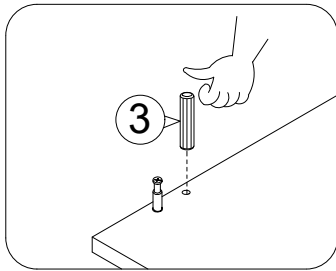

6

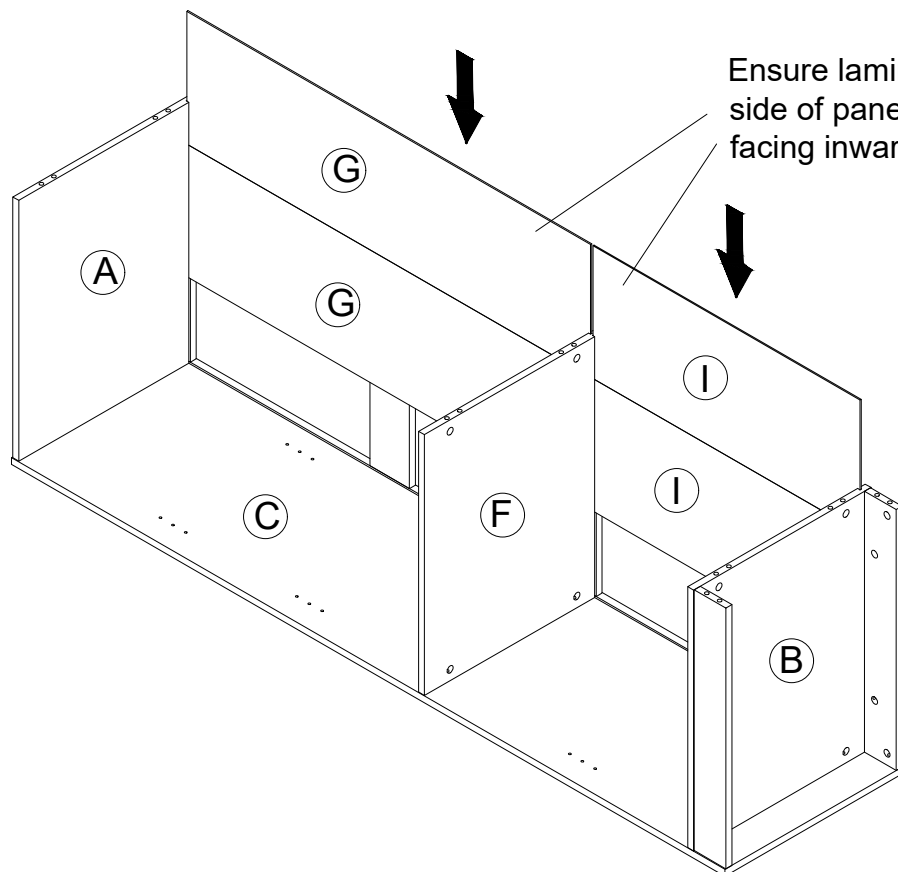

Ensure laminated side of panels are facing inwards.

7



① x 10



③ x 9



This is how a cam nut works.....

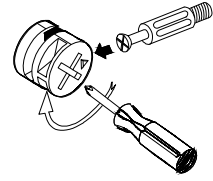

The head of the cam bolt goes into the open mouth of the cam nut. You then turn the cam nut so it tightens over the bolt.

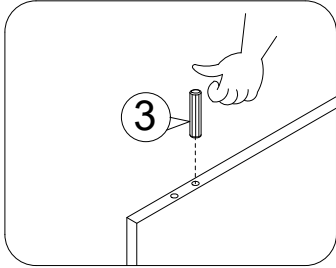
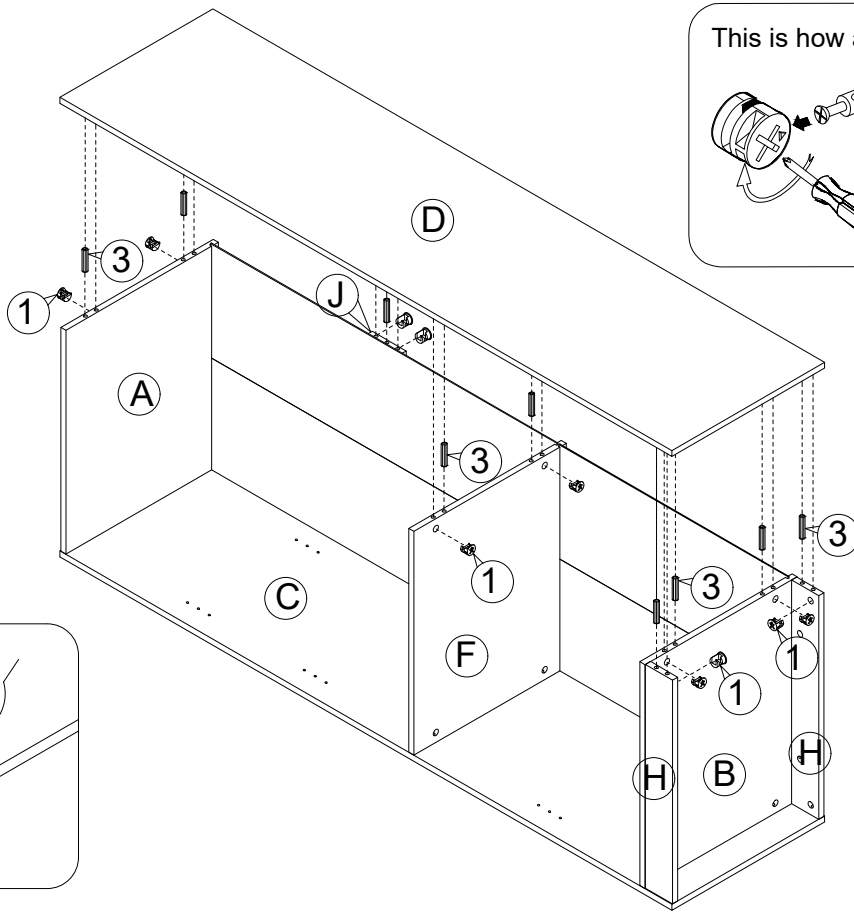

8



⑤ x 4



④ x 8

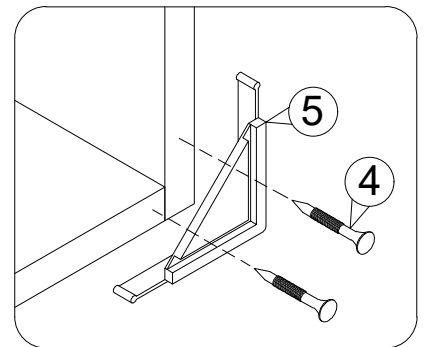
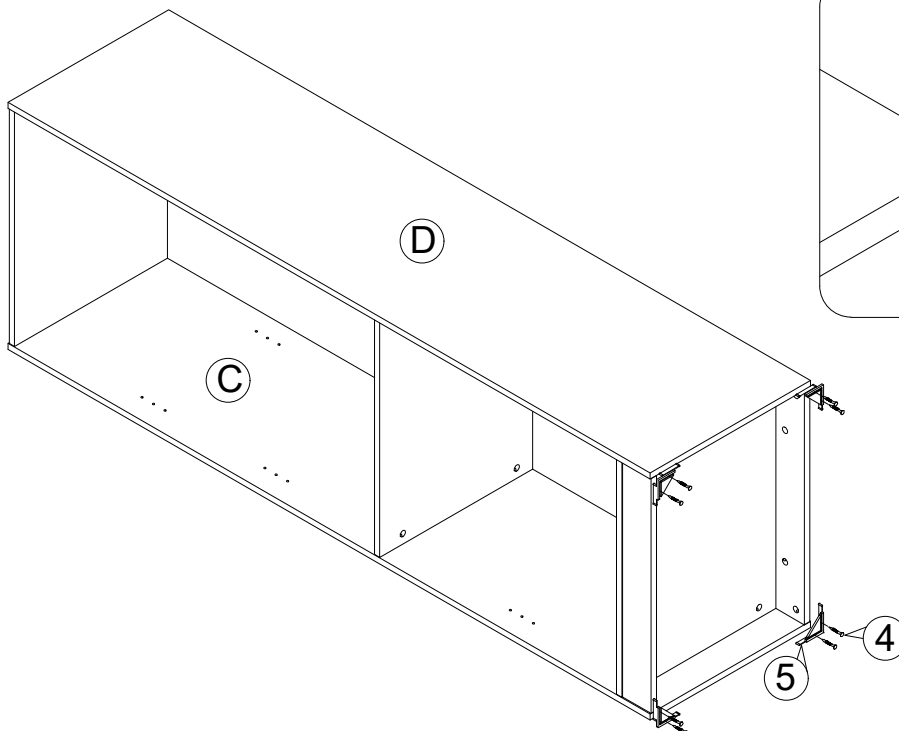
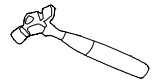

9



⑥ x 12

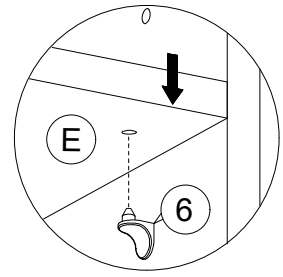
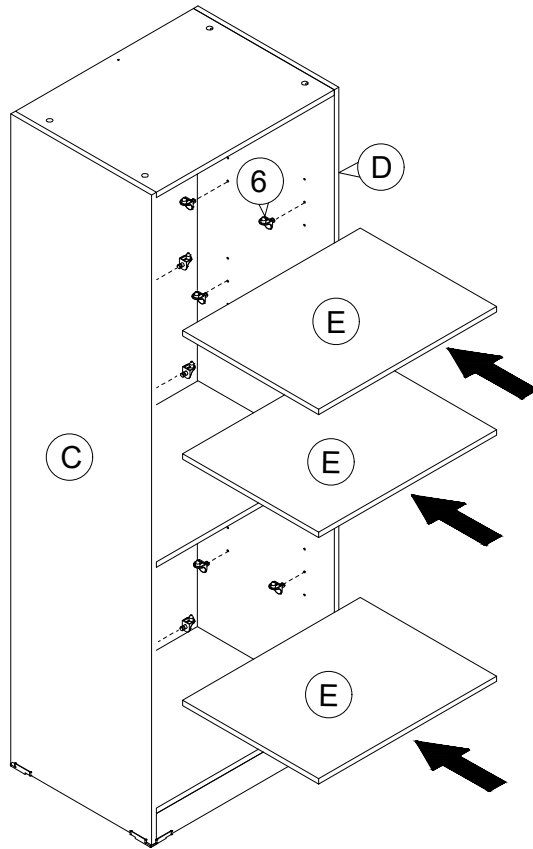

Align the Shelf Support to the hole of Adjustable Shelf Panel.

10



⑦ x 12



⑧ x 12

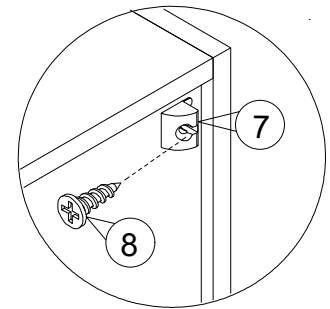
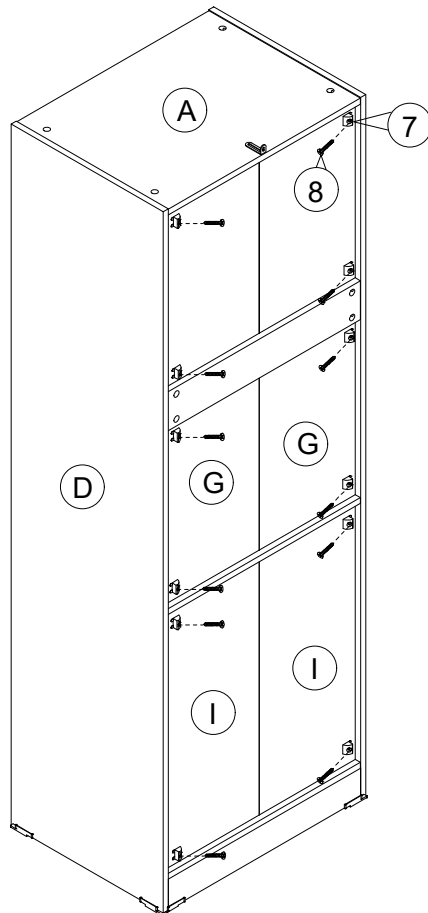

11

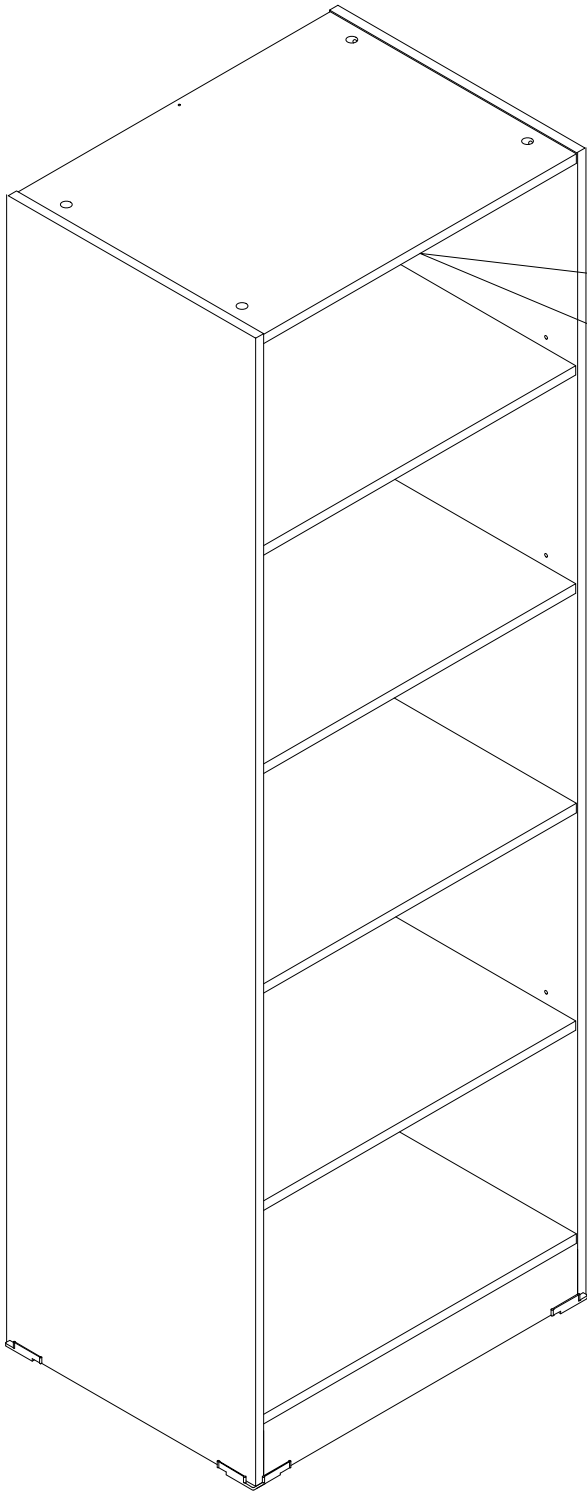

 on the back side of the top panel next to coo label

⚠ WARNING		
		<p>Children have died from furniture tipover.</p> <ul style="list-style-type: none">• ALWAYS secure it with an anchor device.• NEVER allow children to stand, climb or hang on drawers, doors, or shelves.• NEVER open more than one drawer at a time.• Place heavy items down low
<p>NEVER put a TV on this furniture </p> <p>This is a permanent label. Do not remove!</p>		

SAFETY BRACKETS INSTRUCTIONS

This furniture poses a tipping risk and as such must be secured to a wall using the provided tipping kit.

1. Attach one Mounting plate to the wall with the Large screws. Make sure to attach the Mounting Plate into a stud. If mounting into brick or masonry you will need to acquire wall anchors. Please enquire with your local hardware supplier for appropriate fixings.
2. Attach the second Mounting Plate to the furniture frame with the Short screws .
3. Move the furniter to its final position. Thread a Wall Strap through the both Mounting Plated and tighten until snug. Do not over tighten.
4. Make sure that the Mounting Plated are firmly attached to the wall and fumiture and that the Wall Strap is snug.

HARDWARE



1PC
20 x 40 x 1.2mm
Wall Bracket

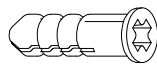

1PC
Ø9 x Ø6 x 25mm
Plastic Screw

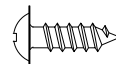

1PC
Ø9 x Ø4 x 15mm
Screw

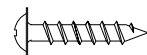

1PC
Ø9 x Ø4 x 25mm
Screw

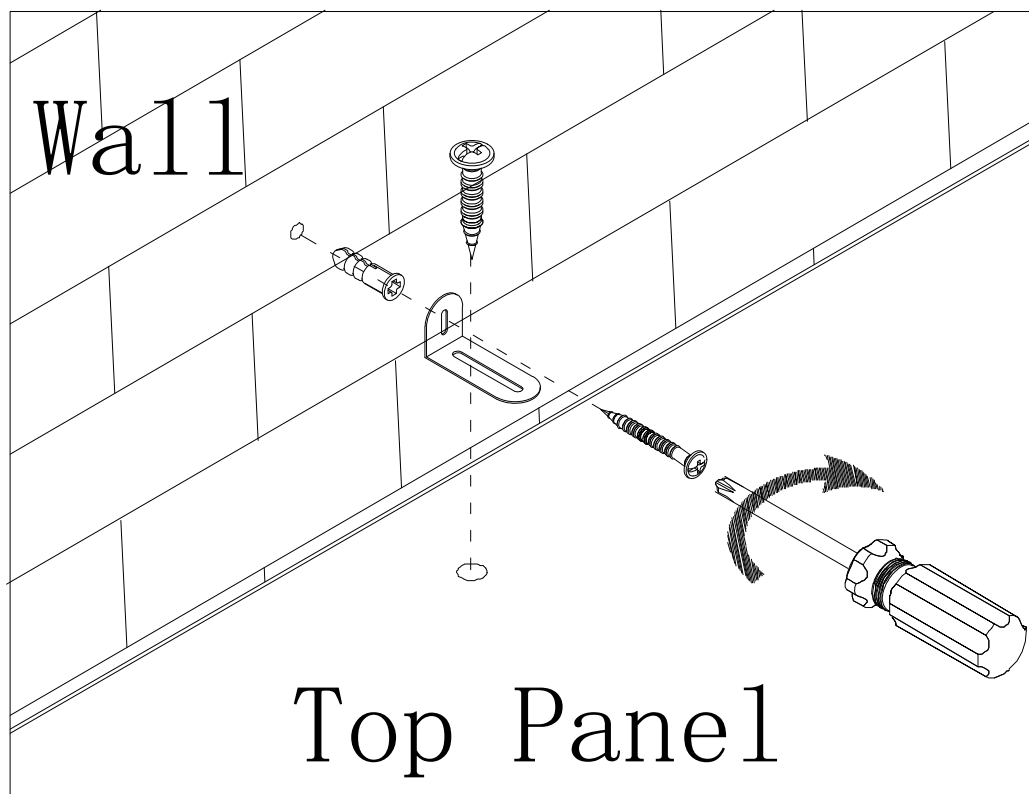

12

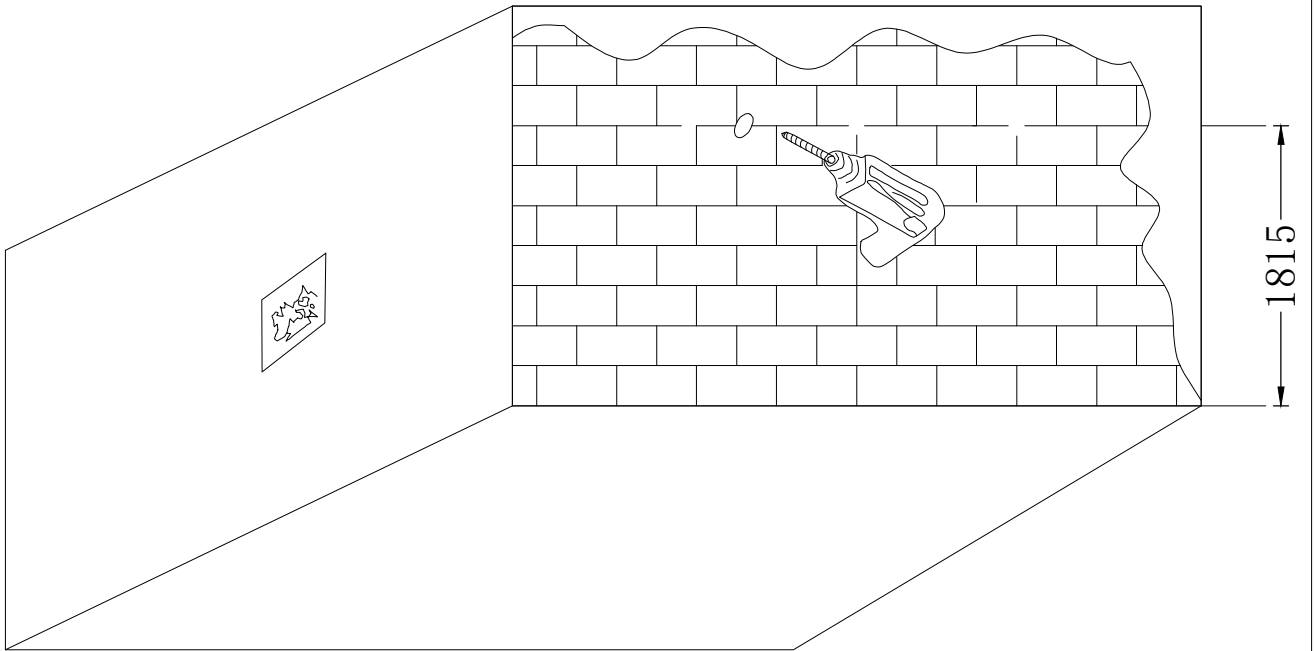

13

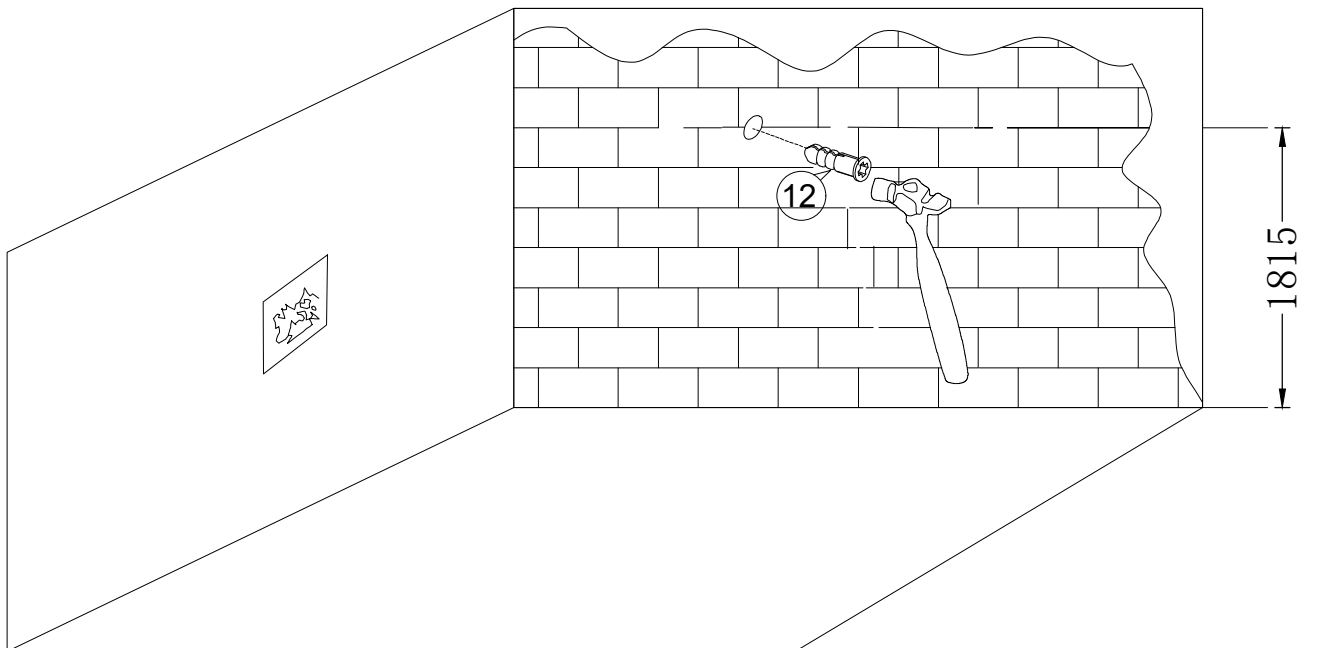

14

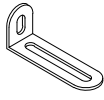

11 x 1



10 x 1

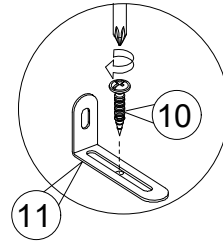
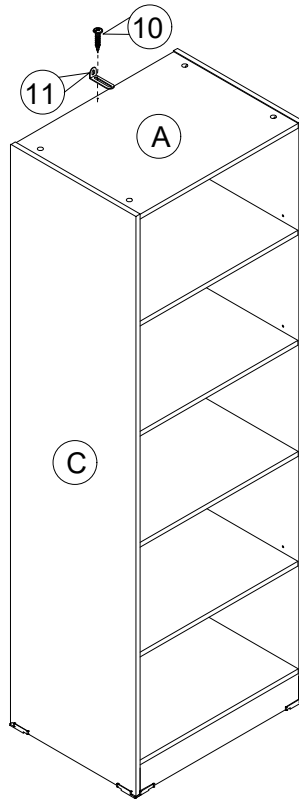

15



9 x 1

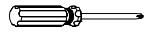

wall

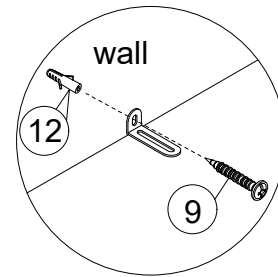
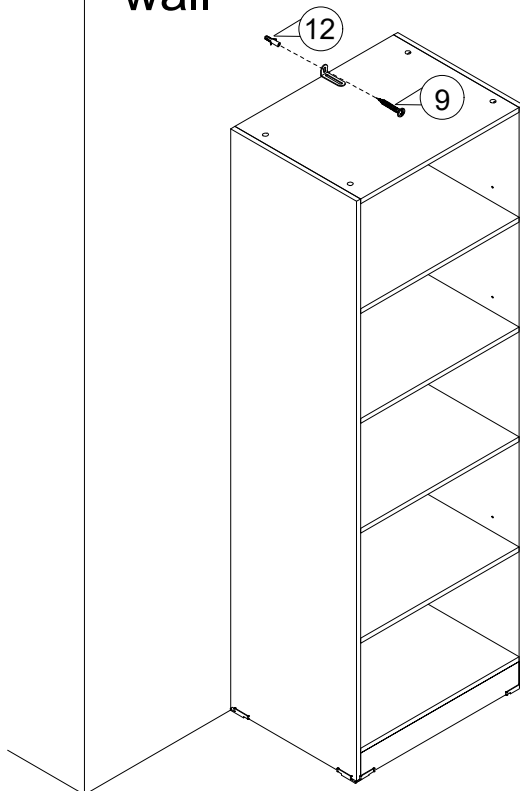

To protect your furniture, we suggest the following:

- Avoid placing your furniture in direct sunlight.
- Do not place furniture directly under windows.
- Do not place sharp materials (knife, fork, etc.) directly onto your furniture as sharp material may scrape and damage the finish.
- Do not place material with high temperature directly onto the surface surface of furniture.
- Clean up spills quickly. Water left over a prolonged period of time may cause damage. Alcohol, perfume, nail polishes, aftershave and some medication may cause severe finish damage if not cleaned immediately.
- Use a clean, soft, dry, lint free absorbent cloth to clean your furniture. Do not use any detergent as they may contain ingredients that may react and damage the finish.
- **NOTE:** If the above care advise is not adhered to your product warranty may become void.