

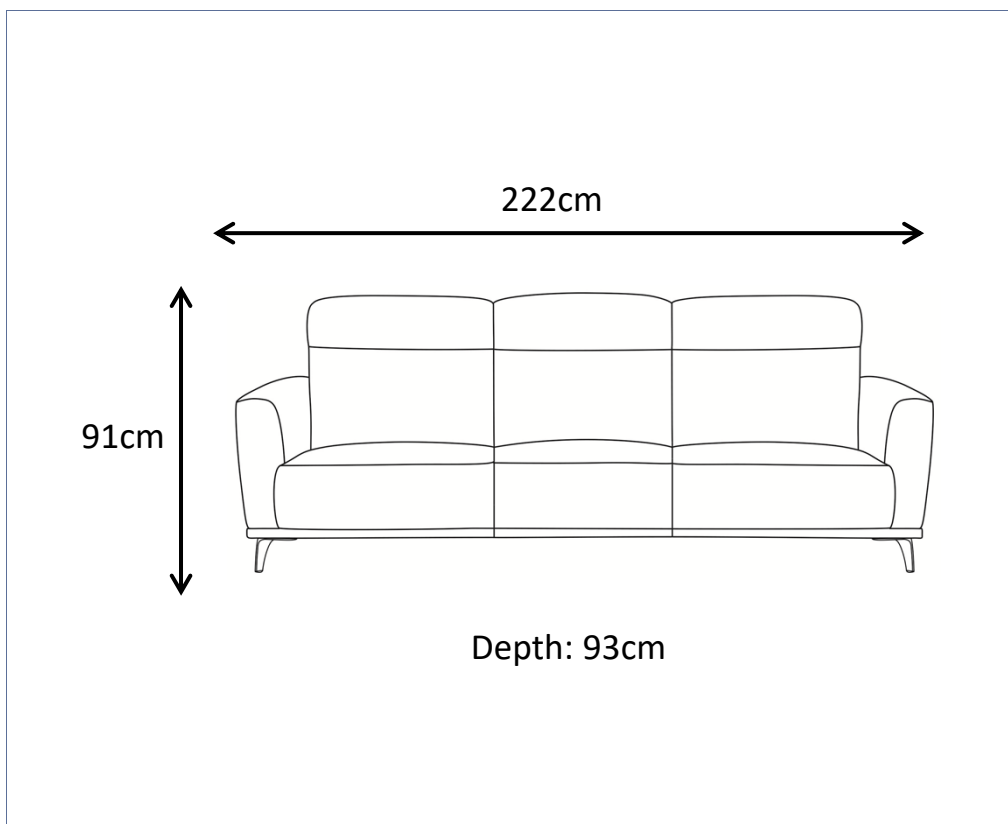

**ASSEMBLY INSTRUCTION**  
**MONDRICH LEATHER 3S**  
**ITEM CODE 83255**

Imported by Amart Furniture Pty Ltd, Qld, Brisbane Australia.  
For any assistance with assembly or for missing parts please phone  
Amart Furniture, Customer Service Free call 1800 351 084





Imported by Amart Furniture Pty Ltd, Qld, Brisbane Australia.  
For any assistance with assembly or for missing parts please phone  
Amart Furniture, Customer Service Free call 1800 351 084

## PRE-ASSEMBLY PREPARATION







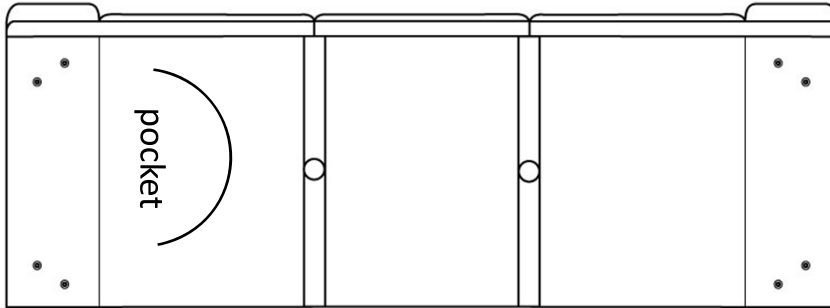

### Before you start:

1. Choose a clean, level, spacious assembly area. Avoid hard surfaces that may damage the product
2. Take care when lifting. Product should be assembled as near as possible to the point of use
3. Ensure that you have all required contents for complete assembly
4. Always read the assembly instructions carefully before beginning assembly.
5. Keep all hardware parts and packaging out of reach of small children.
6. Do not over tighten the screws and bolts as this may damage the threads

	
ALLOW 30MINUTES	PEOPLE REQUIRED
ADDITIONAL TOOLS REQUIRED	

Step1: Locate package of sofa legs with fittings that is placed into zipper pocket at the bottom of 3-Seater.



<b>f. Bolt</b> M8X50  5pcs	<b>g. Washer</b> 25*8.5*2mm  5pcs	<b>h. Spring Washer</b> (16*10*2MM)  5pcs		
<b>a. Metal Leg</b>  4pcs	<b>b. Plastic Leg</b>  2pcs	<b>c. Bolt</b> M8X40  8pcs	<b>d. Washer</b> 18*8.5*2mm  8pcs	<b>e. Allen Key</b> M6  1pcs

Step2: Tighten the metal legs (a) to the bottom of 3-Seater with bolts (c) and washers (d) by Allen key (e), then Secure the plastic legs (b) by placing the leg in the pre-drilled hole and turning the leg in a clockwise direction to tighten.

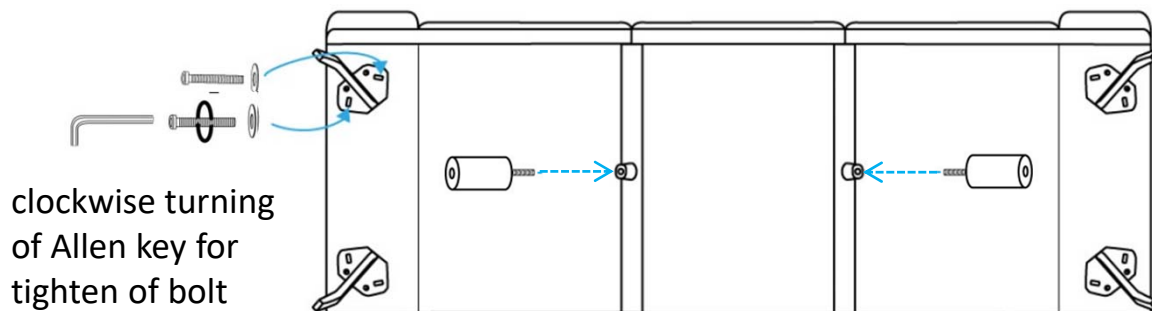

Step3: Remove protective packaging from the 3-Seater backrest packaged individually. Then tighten the backrest to the seat with bolts (f) , washers (g) and spring washers (h) by Allen key (e).

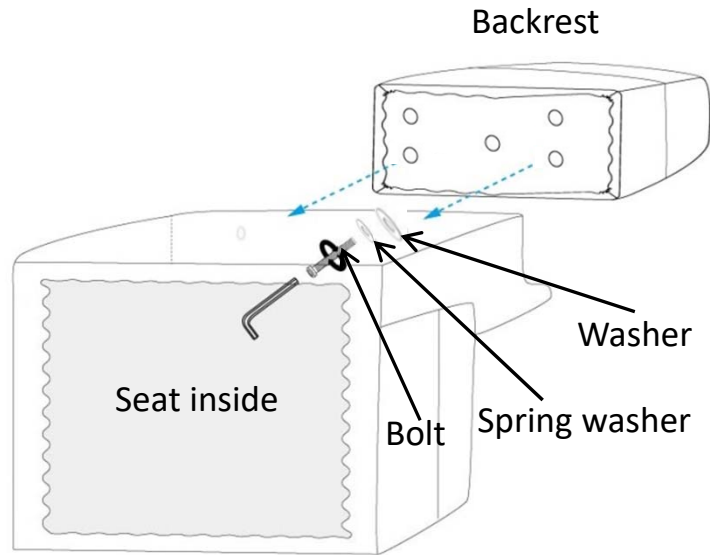

clockwise turning  
of Allen key for  
tighten of bolt

ASSEMBLY IS COMPLETE

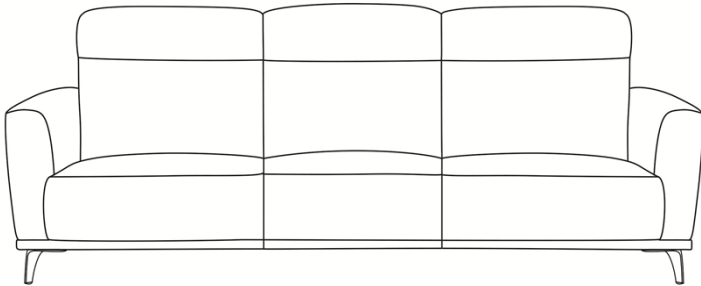

# Product Care for Leather Items

When necessary brush or vacuum away dust and grit. Wipe over with a soft, clean, colourfast cloth

## **FOR SPOTS AND SPILLS:**

- Wipe excess liquid up immediately with an absorbent cloth or sponge

## **FOR OVERALL CLEANING:**

- We recommend cleaning every 3-4 months with leather cleaner followed by applications of leather protector
- Always follow directions on packs

## **NOTES:**

- Accumulation of perspiration and body oils on arm pads, headrests, etc. may damage your leather. These areas may require more frequent cleaning
- Leather is not recommended for users on frequent medication. Particularly heart, blood pressure, diabetes or chemotherapy medication. This medication can seep through the skin and when combined with perspiration, attacks the protective polyurethane coating of the leather
- Leather is a natural product and any stress may result in tears. Additionally when stretched the leather might not completely return to its original shape. Therefore when leather is used more intensively it may become loose over time
- If cushions are sewn to the frame, any pulling or tugging might result in a tear. Please avoid any leaning, sitting or reaching over the back/arms of the sofa
- To keep your cushions looking fluffy and new, use seating evenly
- Leather is not resistant to animals. Allowing pets on your leather is not recommended. Their claws and jaws may scratch the covers, which can lead to expensive repair. Their saliva is acidic and may also harm the leather finish

## **DO NOT:**

- Dry clean or machine wash
- Expose leather to direct sunlight, intensive heat, weather or soak unnecessarily. Always avoid excessive hard rubbing
- Use saddle soap, detergents, solvents, abrasives, unidentified leather cleaners, suede cleaners or any products containing silicon or solvents
- Use silicone based leather care products. These can damage the coating over time. Any leather care product with an oily or greasy feel should be avoided
- Expose leather to new clothing, cushions or throws as this may lead to dye transfer and permanent staining. Ensure these items are colourfast before placing them on the leather