

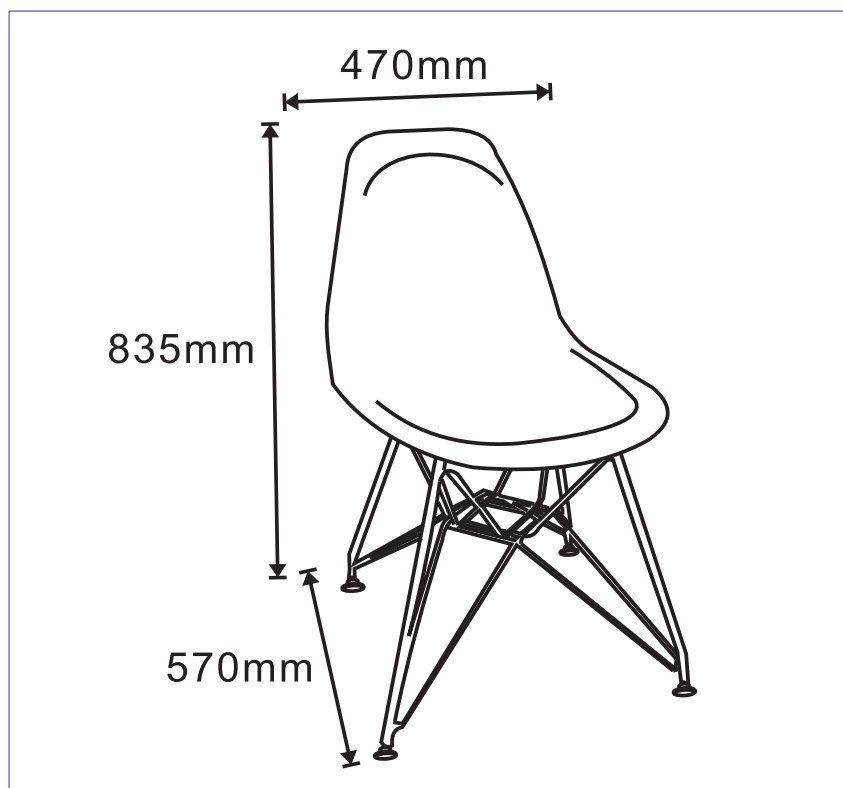

ASSEMBLY INSTRUCTION  
ZETA DINING CHAIR  
ITEM CODE 49305

Imported by Amart Furniture Pty Ltd, Qld, Brisbane Australia.  
For any assistance with assembly or for missing parts please phone  
Amart Furniture, Customer Service Free call 1800 351 084



Imported by Amart Furniture Pty Ltd, Qld, Brisbane Australia.  
For any assistance with assembly or for missing parts please phone  
Amart Furniture, Customer Service Free call 1800 351 084

## PRE-ASSEMBLY PREPARATION

### Before you start:





1. Choose a clean, level, spacious assembly area. Avoid hard surfaces that may damage the product.
2. Take care when lifting. Product should be assembled as near as possible to the point of use.
3. Ensure that you have all required contents for complete assembly.
4. Always read the assembly instructions carefully before beginning assembly.
5. Keep all hardware parts and packaging out of reach of small children.
6. Do not over tighten the screws and bolts as this may damage the threads.

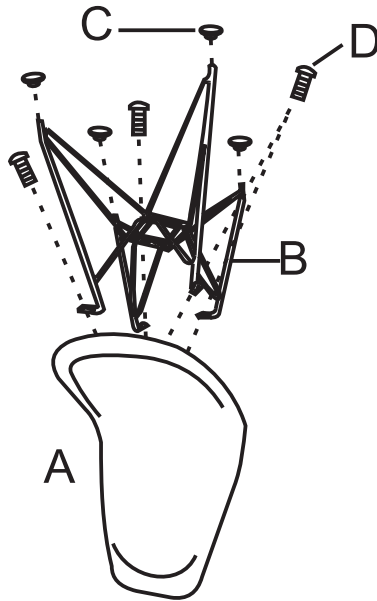

# PARTS LIST



<b>A</b>	<b>SEAT</b>
<b>B</b>	<b>LEG</b>
<b>C</b>	<b>LEG GLIDE</b>
<b>D</b>	<b>BOLT</b>
<b>E</b>	<b>Allen key</b>

 A × 1pcs	 B × 1pcs	 C × 4pcs
 D × 4pcs M8 x 25mm	 E × 1pcs M8	

STEP 1: Tighten the Leg (B) to Seat (A) with Bolts (D) by Allen key(E).

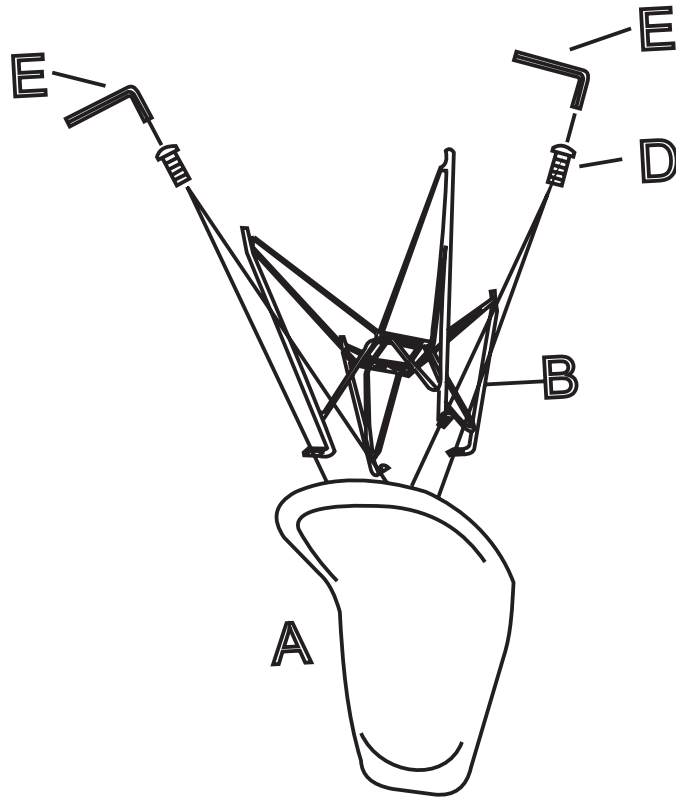

STEP 2: Insert Leg Glide (C) into Leg (B).

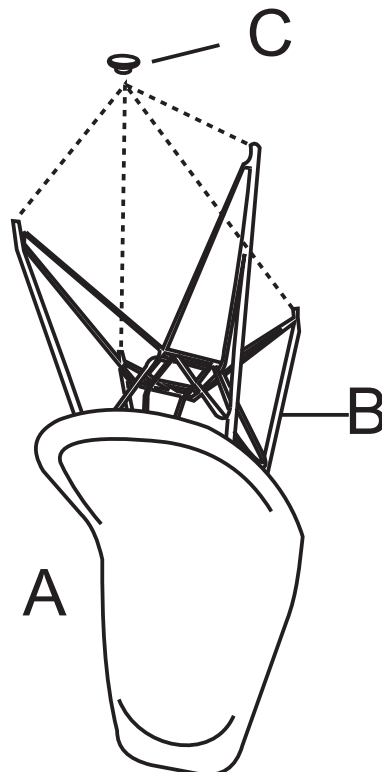

ASSEMBLY IS COMPLETE

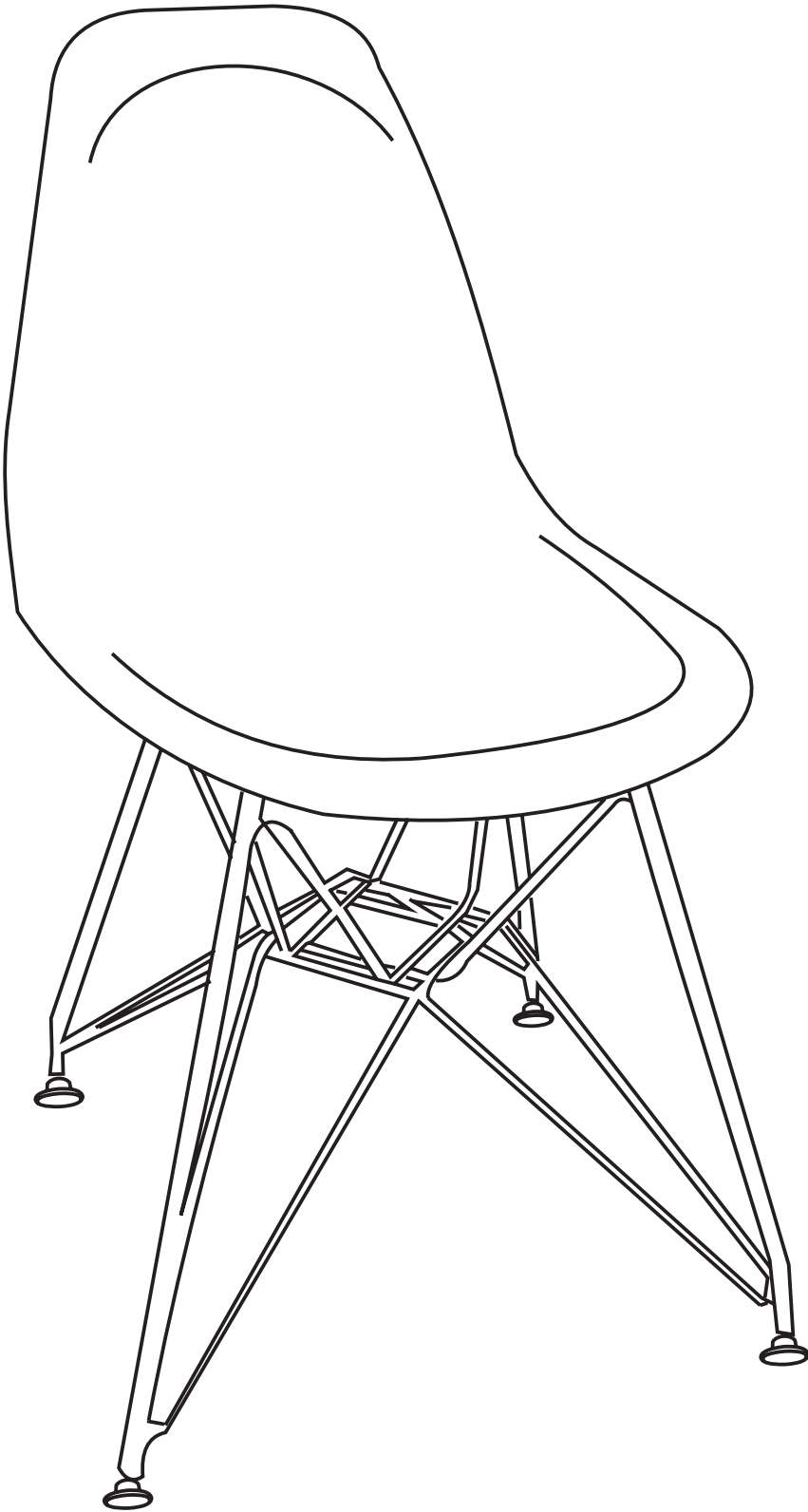

## **IMPORTANT: CARE GUIDE FOR YOUR ABS FURNITURE**

*Congratulations! You have just purchased a quality product from Amart Furniture, Australia's largest discount furniture retail store. Please read on for important information regarding your purchase...*

Our furniture is built to last. Following these steps for basic care should protect your investment for years to come.

Dust frequently with a clean damp lint-free cloth. This will help remove abrasive build up which can damage a finish over time.

Do not place hot objects on any furniture surface. Always use a hot plate. Laminate and lacquer finishes on table tops provide added scratch and heat resistance to our furniture, but they can still be damaged without proper care.

Avoid exposing your furniture to strong sunlight, heat outlet, open windows or dampness. Prolonged exposure to direct sunlight can fade the finish of your furniture, while extreme temperature and humidity changes can cause cracking or splitting.

Do not expose your furniture to any liquids. Never allow water to sit on your furniture. Alcohol, nail polish and perfume are also dangerous as they will dissolve the lacquer finish on contact and may require professional repairs.

