

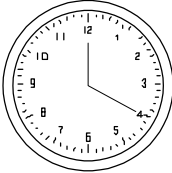

Imported by Amart Furniture Pty Ltd, Qld, Brisbane Australia.  
for any assistance to assembly or for missing parts please phone  
Amart Furniture, Customer Service Freecall 1800 351 084

# PRE-ASSEMBLY PREPARATION

## BEFORE YOU START :



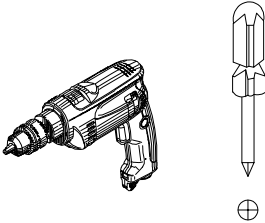

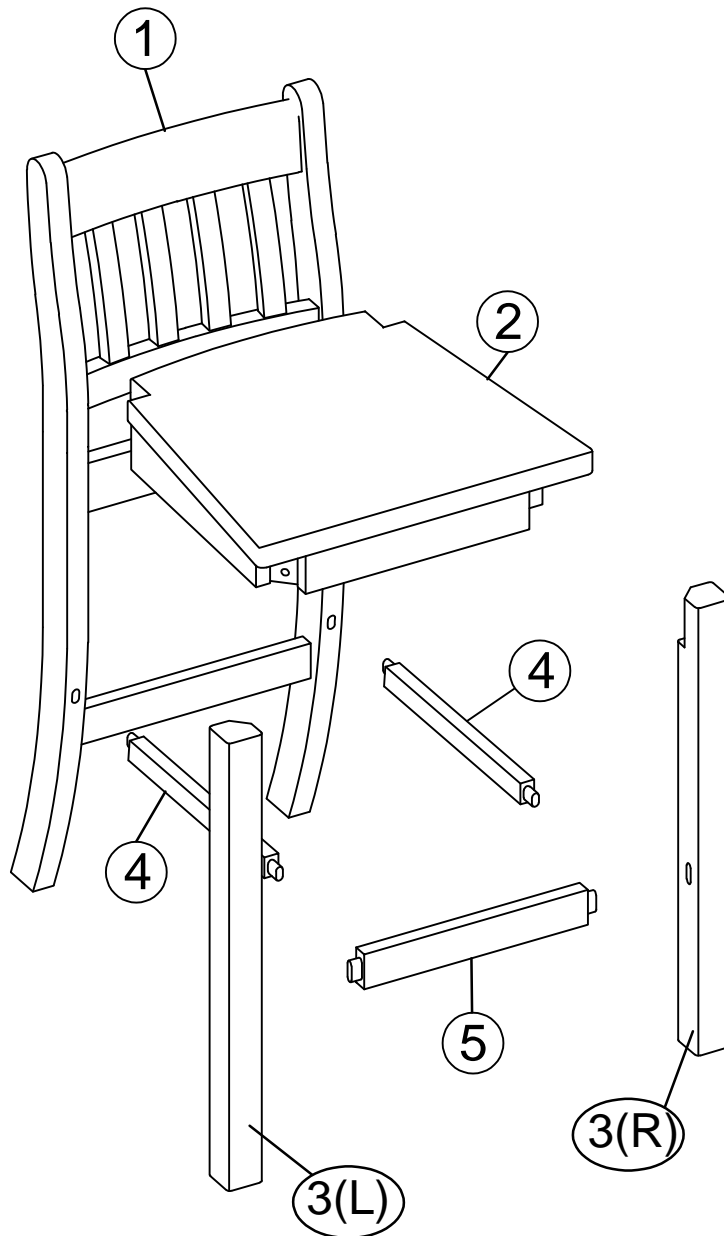

1. Choose a clean, level, spacious assembly area. Avoid hard surfaces that may damage the product
2. Take care when lifting. Product should be assembled as near as possible to the point of use
3. Ensure that you have all required contents for complete assembly
4. Always read the assembly instructions carefully before beginning assembly.
5. Keep all hardware parts and packaging out of reach of small children.
6. Do not over tighten the screws and bolts as this may damage the threads

	
ALLOW 20 MINUTES	2 PEOPLE REQUIRED
	<p>We recommend using screw driver to put this item together. However if you choose to use a power drill it must be used on <b>LOW SPEED (LOW TORQUE)</b> as too much pressure could damage the product.</p>
ADDITIONAL TOOLS REQUIRED	

# PARTS LIST



1	CHAIR BACK	1 PC	4	U STRETCHER	2 PCS
2	SEAT FRAME	1 PC	5	FRONT STRETCHER	1 PC
3	LEG (L-R)	2 PCS			





<b>A</b> BOLTS  M6x80: 4 pcs	<b>B</b> BOLTS  M6x50: 4 pcs	<b>C</b> BOLTS  M6x40: 1 pc	<b>D</b> SPRING WASHER  M6x1.2x9: 9 pcs
<b>E</b> FLAT WASHER  M6x2x19: 9 pcs	<b>F</b> SCREW  M4x40: 6 pcs	<b>G</b> ALLEN KEY  M4x59: 1 pc	

**Step 1 :**

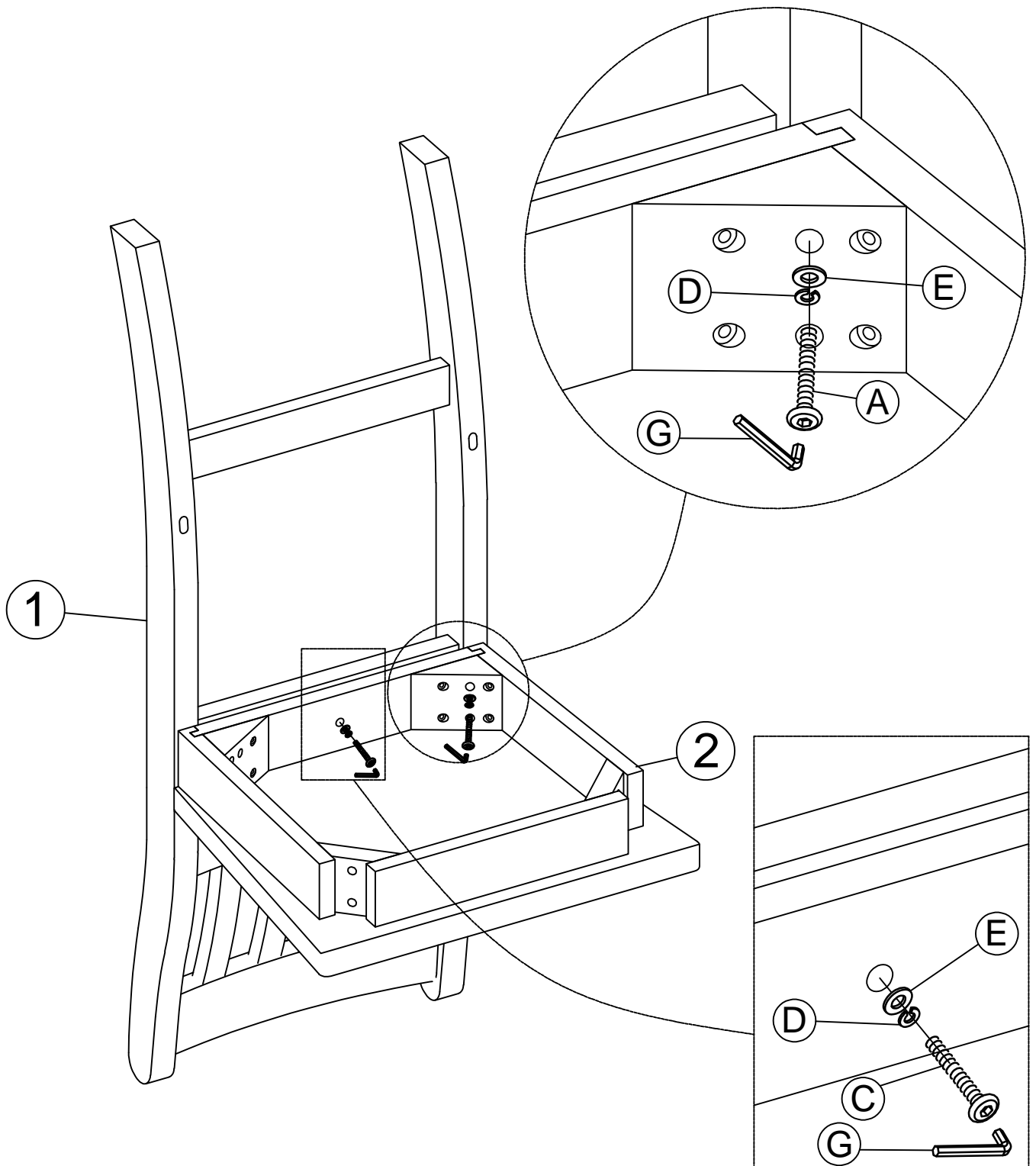
- Attach chair back ( 1 ) to seat frame (2) using bolts (A,C), Spring Washers(D) and Flat Washers(E).

- Tighten with Allen Key (G).



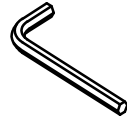

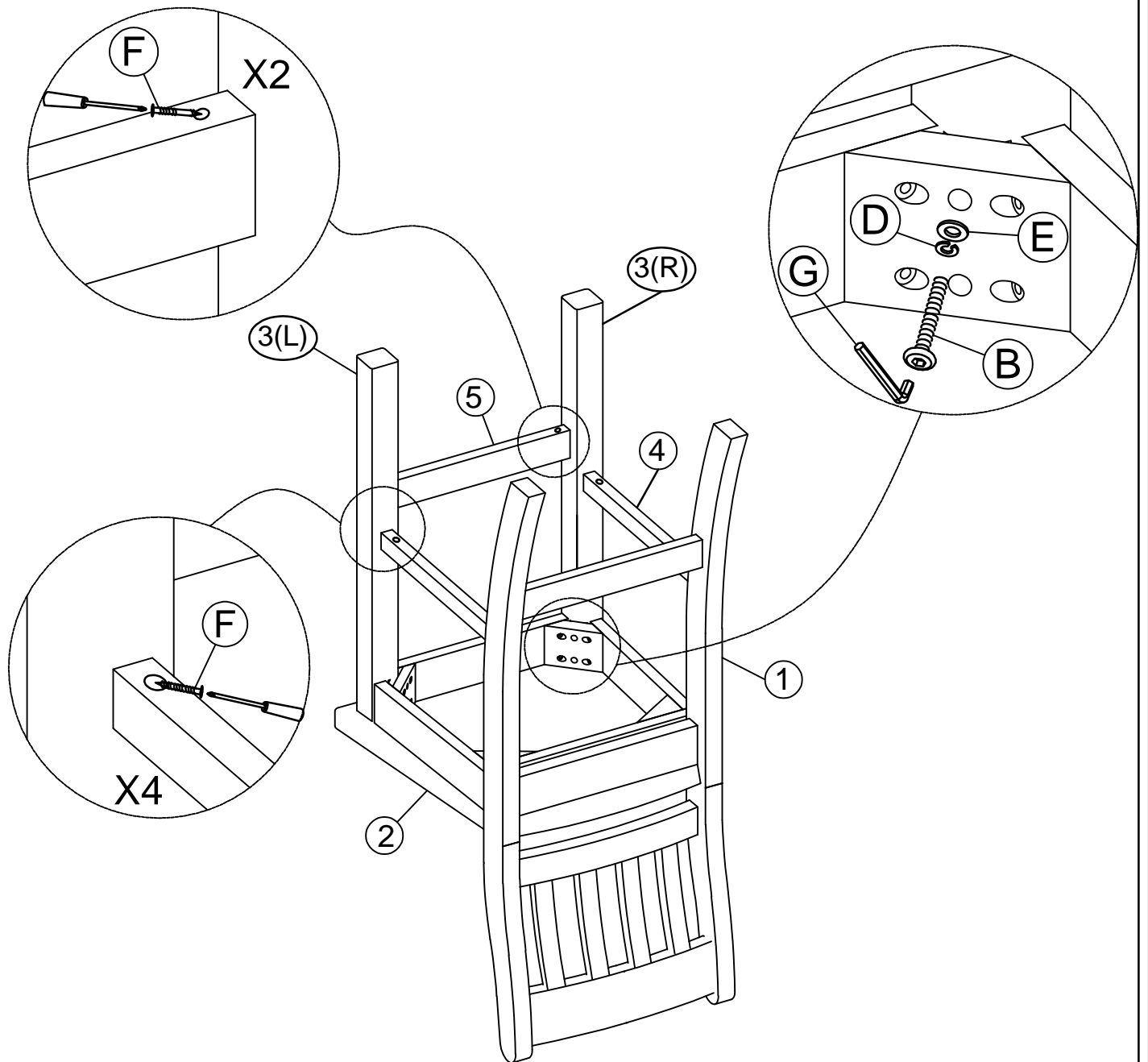

<b>A</b> BOLTS  M6x80: 4 pcs	<b>C</b> BOLTS  M6x40: 1 pc	<b>D</b> SPRING WASHER  M6x1.2x9: 5 pcs	<b>E</b> FLAT WASHER  M6x2x19: 5 pcs	<b>G</b> ALLEN KEY  M4x59: 1 pc
---	--	--	---	--

**Step 2 :**

- Attach leg (3(L-R)) to front stretcher (5) using screw (F).
- Attach U stretcher (4) to leg (3), chair back ( 1 ) using screw (F).
- Attach leg (3) to seat frame (2) use bolt (B), spring washers (D) and flat washers (E).
- Tighten with Allen Key (H).

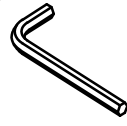

“Important Note - Before finally tightening the bolts, place the assembled chair upright on a level surface and sit carefully on the chair to ensure the chair legs are aligned and level. Then fully tighten all bolts and your chair is ready for use.”

<b>B</b> BOLTS  M6x50: 4 pcs	<b>D</b> SPRING WASHER  M6x1.2x9: 4 pcs	<b>E</b> FLAT WASHER  M6x2x19: 4 pcs	<b>F</b> SCREW  M4x40: 6 pcs	<b>G</b> ALLEN KEY  M4x59: 1 pc
---	--	---	--	--

## ASSEMBLY COMPLETE

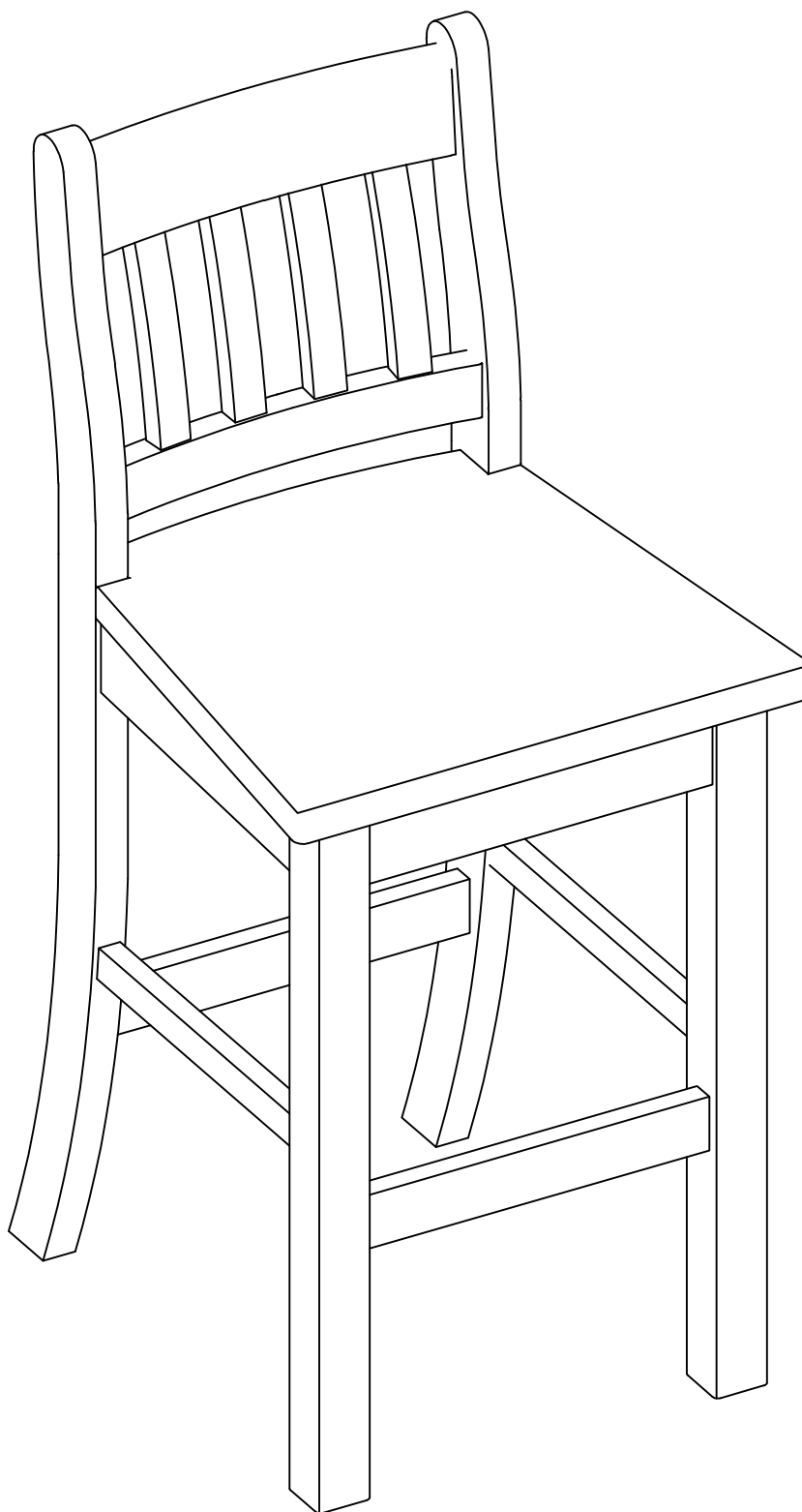

**Do Not:** Use chair/stool as a ladder. Climb on the chair/stool. Stand on the foot-rest of the chair/stool, as this could lead to the stool becoming unbalanced and overturning.



Product : **CALLAGHAN BAR STOOL**

Item Code : **81829**

## **Product Care:**

As you timber is supplied from sustainable forests there will be natural variations in surface texture and grain like knots, mineral streaks and sap runs that may affect the finish. These differences in character are not defects, but distinctions that make each piece of furniture unique. Our furniture is built to last. Following these steps for basic care should protect your investment for years to come.

- Dust frequently with a clean damp lint-free cloth. This will help remove abrasive build up which can damage a finish over time.
- Do not place hot objects on any furniture surface. Always use a hot plate or placemat. Laminate and lacquer finishes on table tops provide added scratch and heat resistance to our furniture, but they can still be damaged without proper care.
- Avoid exposing your furniture to strong sunlight, heat outlet, open windows or dampness. Prolonged exposure to direct sunlight can fade the finish of your furniture, while extreme temperature and humidity changes can cause cracking or splitting.
- Do not expose your furniture to any liquids. Never allow water to sit on your furniture. Alcohol, nail polish and perfume are also dangerous as they will dissolve the lacquer finish on contact and may require professional repairs.
- Do not allow plastic to come in direct contact with your furniture. Chemicals in the plastic of placemats etc may soften and mark the finish if left in contact with the furniture for a period of time.