

ASSEMBLY INSTRUCTION  
AYLESBURY  
ACCENT CHAIR  
79991

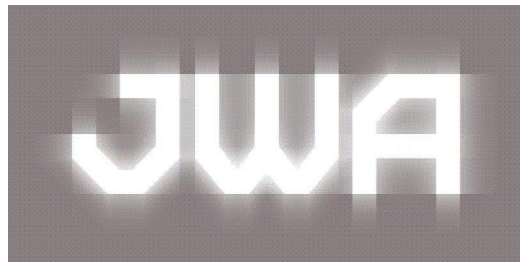

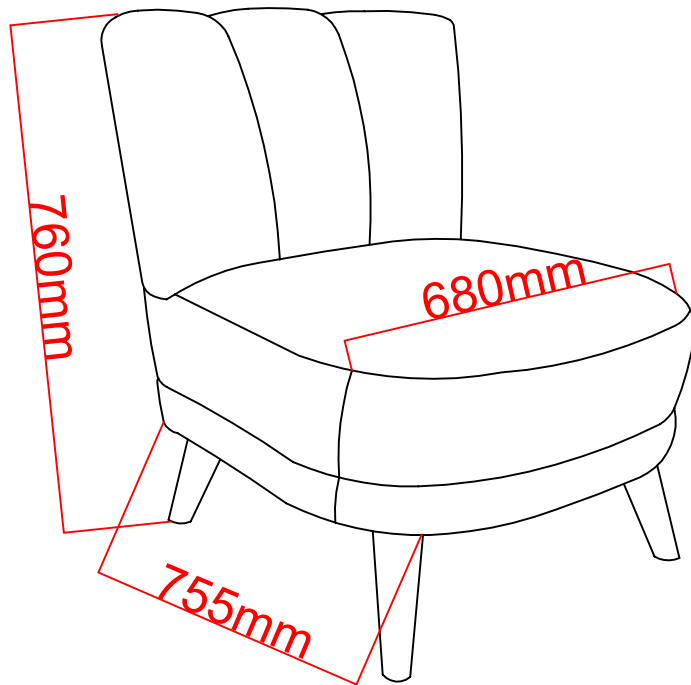

Imported by JWA Furniture Pty Ltd, Qld, Brisbane Australia,  
For any assistance with assembly or for missing parts please refer to your  
receipt



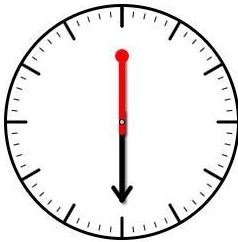

# PRE-ASSEMBLY PREPARATION

## Before you start:

1. Choose a clean, level, spacious assembly area. Avoid hard surfaces that may damage the product
2. Take care when lifting. Product should be assembled as near as possible to the point of use
3. Ensure that you have all required contents for complete assembly
4. Always read the assembly instructions carefully before beginning assembly.
5. Keep all hardware parts and packaging out of reach of small children.
6. Do not over tighten the screws and bolts as this may damage the threads
7. Assembly is to be carried out by a competent adult(s) ONLY
8. During assembly, children should be kept away from the product due to possible risk to injury.
9. Do not use this item if any components are missing or damaged.
10. Please keep the instructions for future reference.

	
Allow 30 min	For 1 persons

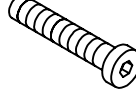
# PARTS LIST

Ⓐ M8X19mm x4pcs  Flat wahser	Ⓑ M5X100mm x1pc  Allen key	Ⓒ M8X50mm x4pcs  Bolt	Ⓓ M8X40mm x4pcs  Wood Dowel
---	---	---	--

Part	Item	QTY
1	Chair	1
2	Leg	4

1

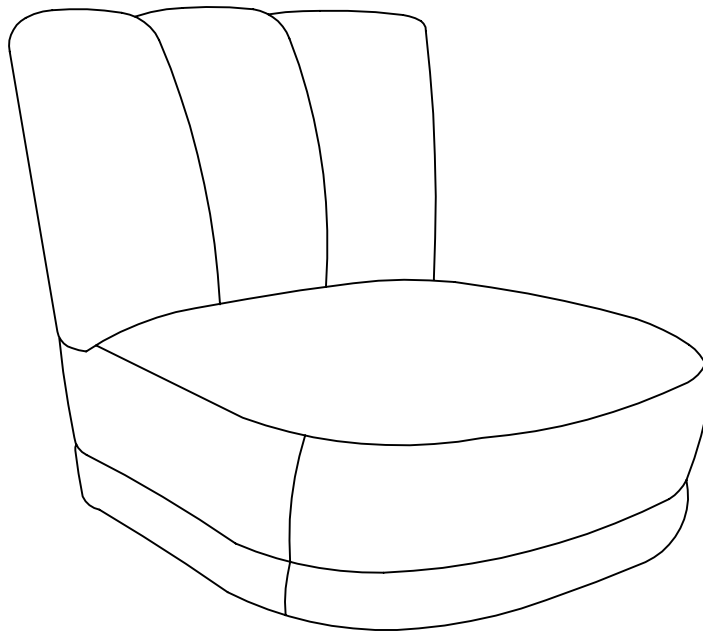

2

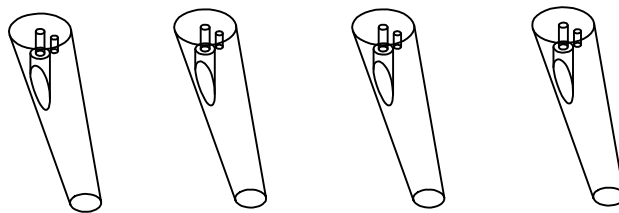

## STEP 1:

Attach Legs (2) to base frame (1) and insert the Wood Dowel (D), then using flat washer (A), and bolt (C) as shown below, then tighten with allen key (B)

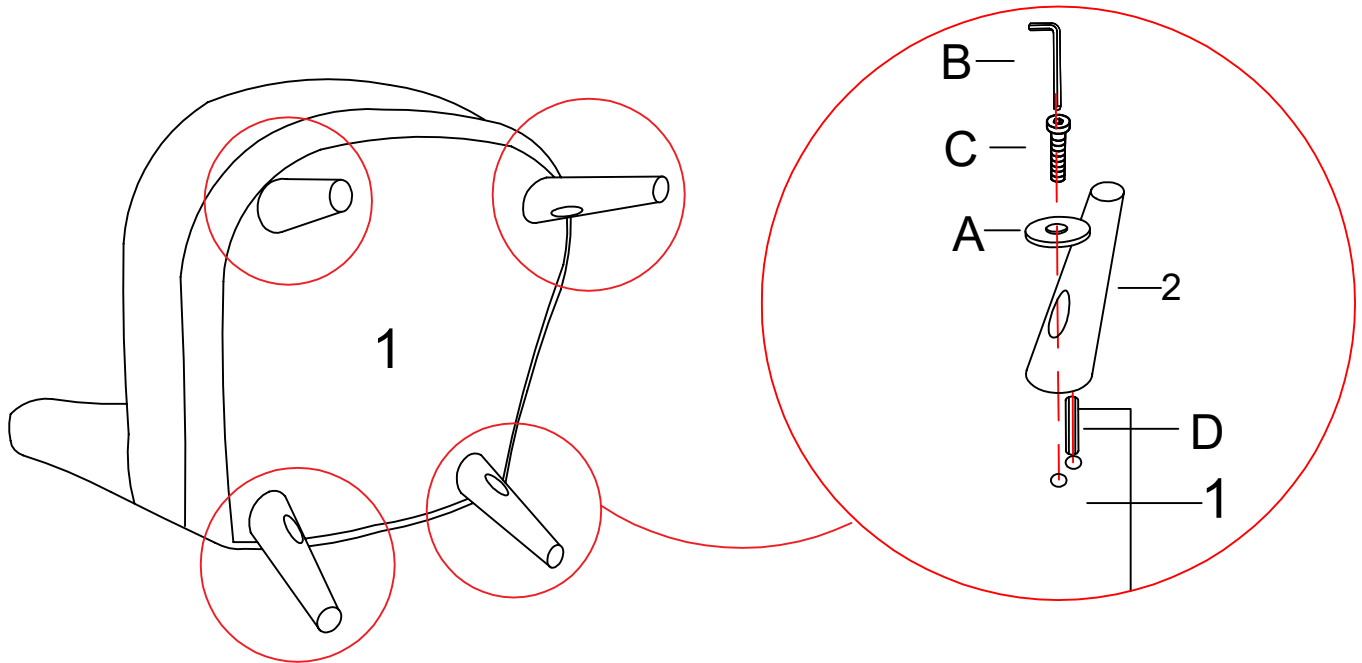

## ASSEMBLY IS COMPLETE

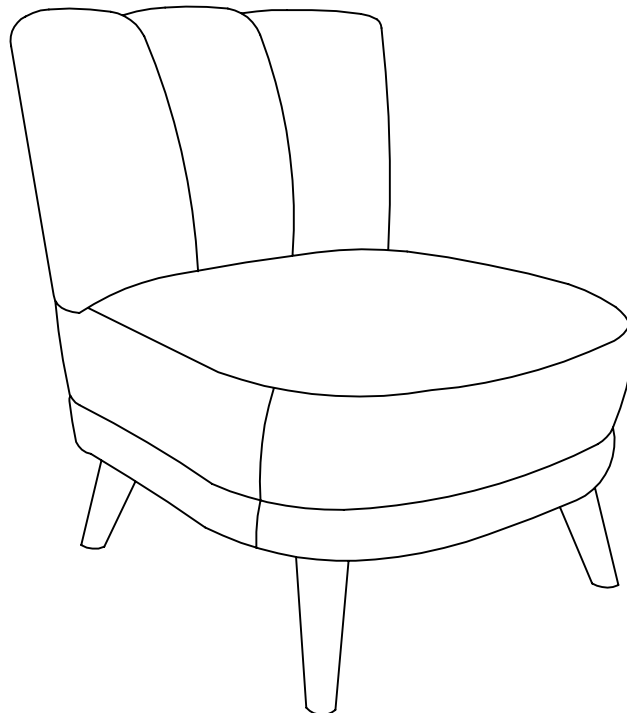

## PRODUCT CARE:

If the glass is chipped or broken, stop using the product and consult place of purchase

### WARNING:

.Do not place very hot or cold items on the glass surface unless adequately thick table mats are used to prevent such items coming in contact with the glass

Do not sit or stand upon the glass surface

Do not use the glass as a chopping surface

Do not strike the glass with hard or pointed items

When cleaning the glass panels use a damp cloth or leather with washing up liquid or soft soap if necessary. Do not use washing powder or any

Other substances containing abrasives since these may scratch the glass

Your furniture is built to last. Following these steps for basic care should protect your investment for years to come

Dust frequently with a clean damp lint-free cloth. This will help remove abrasive build-up which can damage a finish over time

Avoid exposing your furniture to strong sunlight, heat outlet, open

Windows or dampness. Prolonged exposure to direct sunlight can fade the finish of your furniture, while extreme temperature and humidity changes can cause cracking or splitting

Do not allow plastic to come in direct contact with your furniture.

Chemicals in the plastic of placemats etc. may soften and mark the

finish if left in contact with the furniture for a period of time