

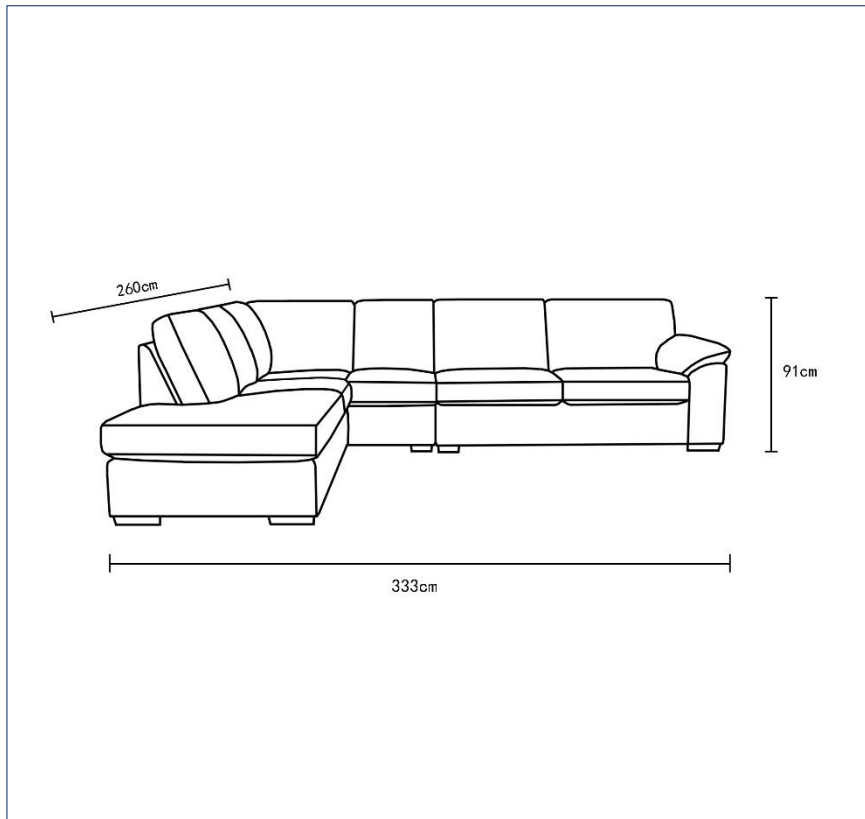

**ASSEMBLY INSTRUCTION**  
**RUMPUS CORNER CHAISE WITH OTTOMAN**  
**ITEM CODE 41708**

Imported by Amart Furniture Pty Ltd, Qld, Brisbane Australia.  
For any assistance with assembly or for missing parts please phone  
Amart Furniture, Customer Service Free call 1800 351 084



Imported by Amart Furniture Pty Ltd, Qld, Brisbane Australia.  
For any assistance with assembly or for missing parts please phone  
Amart Furniture, Customer Service Free call 1800 351 084

## PRE-ASSEMBLY PREPARATION

### Before you start:

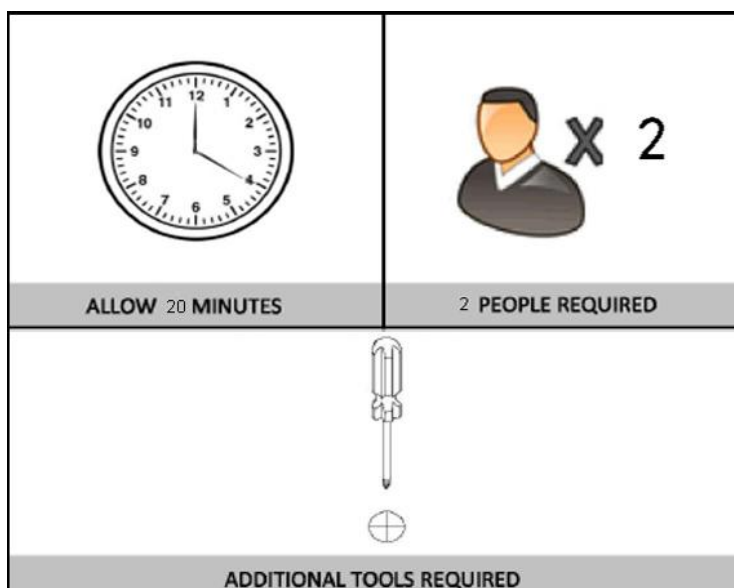

1. Choose a clean, level, spacious assembly area. Avoid hard surfaces that may damage the product
2. Take care when lifting. Product should be assembled as near as possible to the point of use
3. Ensure that you have all required contents for complete assembly
4. Always read the assembly instructions carefully before beginning assembly.
5. Keep all hardware parts and packaging out of reach of small children.
6. Do not over tighten the screws and bolts as this may damage the threads

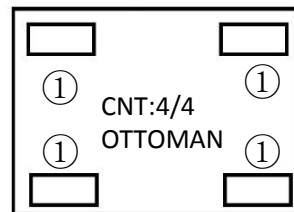
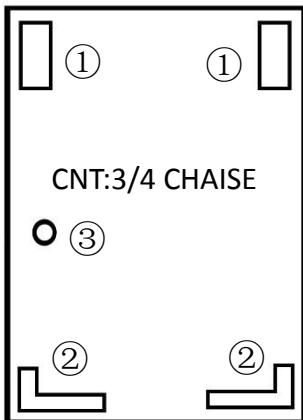
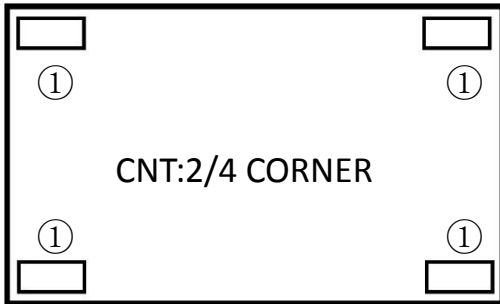

# ASSEMBLY

1	Rectangular Sofa Legs
2	L-shaped Sofa Legs
3	Support Plastic leg



<p>① Rectangular Sofa Legs</p>  <p>X 12 pcs</p>	<p>② L-shaped Sofa Legs</p>  <p>X 4 pcs</p>	<p>③ Support Plastic leg</p>  <p>X 1 pcs</p>
--	--	---

# ASSEMBLY

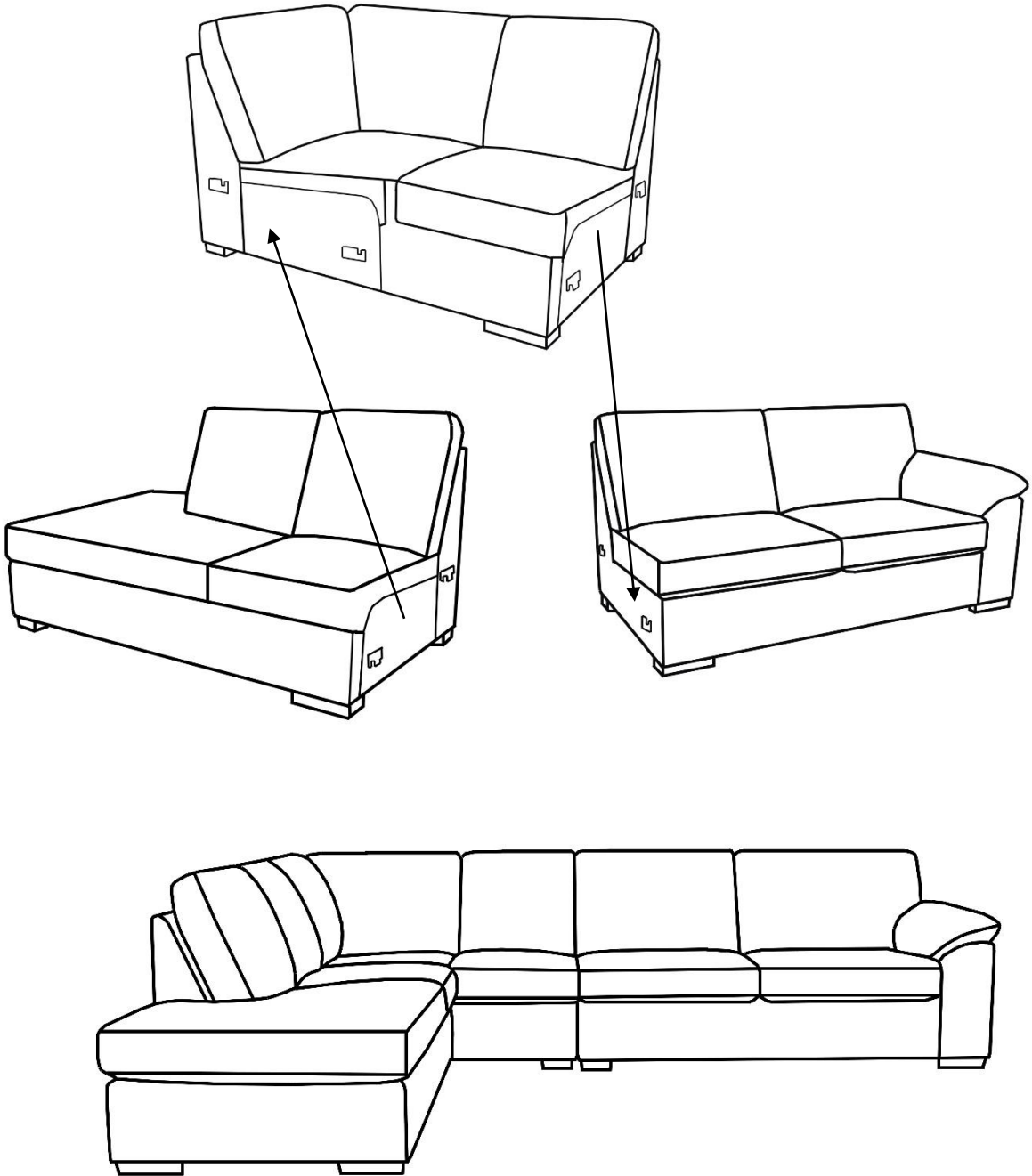

# CARE LABEL

## FABRIC CARE

**REGULAR CARE:** PROTECT FROM DIRECT SUNLIGHT.  
VACUUM REGULARLY USING LOW SUCTION.  
ROTATE REVERSIBLE CUSHIONS REGULARLY.

**CLEANING:**

DO NOT REMOVE CUSHION COVERS FOR SEPARATE  
CLEANING EVEN THOUGH THEY HAVE ZIPPERS.  
DO NOT WASH  
DO NOT DRY CLEAN  
DO NOT SHAMPOO CLEAN  
CLEAN WITH HOT-WATER EXTRACTION MACHINE.  
(HOT) PROFESSIONAL CLEANING RECOMMENDED  
DO NOT USE DISHWASHING OR LAUNDRY  
DETERGENTS  
USE ONLY UPHOLSTERY DETERGENTS  
DO NOT WET FILLING  
DRY IN SHADE AWAY FROM DIRECT HEAT AND  
SUNLIGHT  
ALLOW TO DRY THOROUGHLY BEFORE RE-USE

**SPOT CLEANING:**

DO NOT RUB  
DO NOT SPOT CLEAN WITH ANY SOLVENT.  
TREAT SPILLS AND STAINS AS SOON AS POSSIBLE.  
GENTLY SCRAPE ANY SOIL OR MOP ANY LIQUID  
FROM THE SURFACE OF THE FABRIC.  
APPLY PROPRIETARY CLEANING AGENTS STRICTLY  
ACCORDING TO INSTRUCTIONS TO REMOVE THE  
RESIDUE OF THE SPILL.  
DO NOT SATURATE THE FABRIC OR INTERIOR WITH  
WATER OR OTHER CLEANING LIQUIDS.

**WARNING:** APPLY ONLY WATER-BASED SOIL RESIST  
(FABRIC PROTECTION) TREATMENTS. DO NOT USE  
AEROSOL PRODUCTS.