

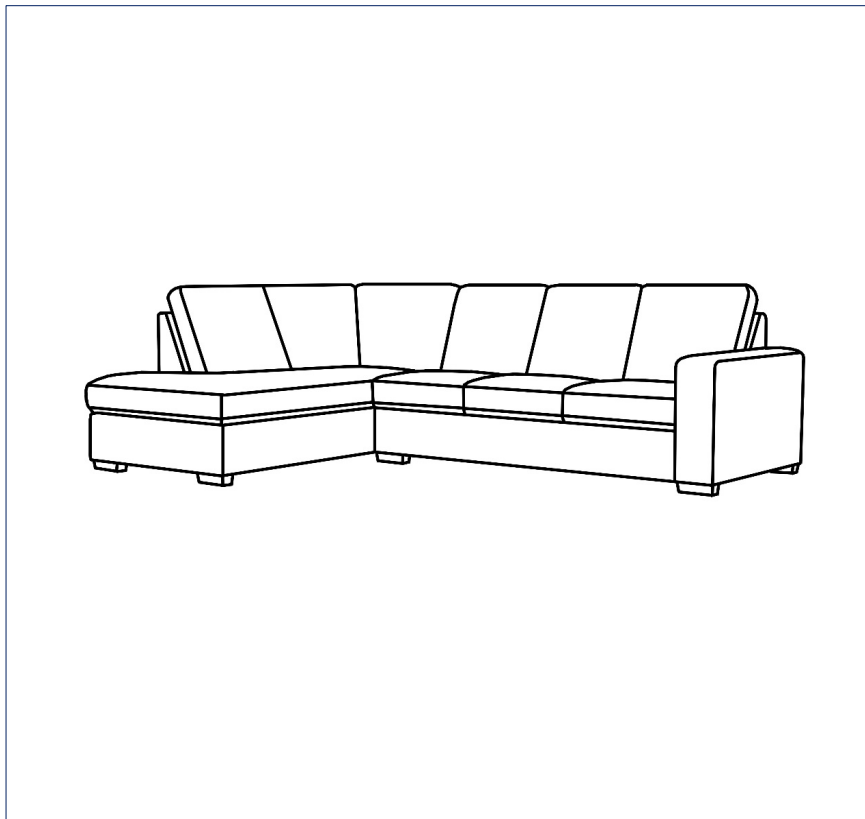

ASSEMBLY INSTRUCTION
KIRBY 4 SEATER LHF CHAISE
ITEM CODE 74942

Imported by Amart Furniture Pty Ltd, Qld, Brisbane Australia.
For any assistance with assembly or for missing parts please phone
Amart Furniture, Customer Service Free call 1800 351 084





Imported by Amart Furniture Pty Ltd, Qld, Brisbane Australia.
For any assistance with assembly or for missing parts please phone
Amart Furniture, Customer Service Free call 1800 351 084

PRE-ASSEMBLY PREPARATION

Before you start:



1. Choose a clean, level, spacious assembly area. Avoid hard surfaces that may damage the product
2. Take care when lifting. Product should be assembled as near as possible to the point of use
3. Ensure that you have all required contents for complete assembly
4. Always read the assembly instructions carefully before beginning assembly.
5. Keep all hardware parts and packaging out of reach of small children.
6. Do not over tighten the screws and bolts as this may damage the threads

	
ALLOW 20 MINUTES	2 PEOPLE REQUIRED
	
ADDITIONAL TOOLS REQUIRED	

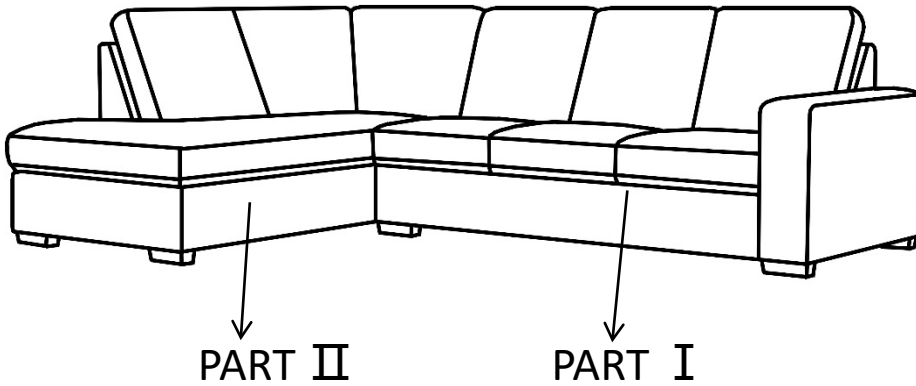

PARTS LIST



Hardware

<i>HARDWARE LIST</i>			
NO.	DESCRIPTION		QTY
A	Inclined Sofa Legs		4 PCS
B	Support Leg		1 PCS
C	screw	6cm 	13 PCS

PART I

<i>HARDWARE LIST</i>			
NO.	DESCRIPTION		QTY
A	Inclined Sofa Legs		4 PCS
B	Support Leg		1 PCS
C	screw	6cm 	13 PCS

PART II

PLEASE TAKE NOTE:
PIECES REQUIRE FOR ASSEMBLY ARE LOCATED INSIDE THE DUST
COVER UNDERNEATH SOFA

Step 1

With 2 people carefully turn lounge over onto a sheet or a piece of cardboard.

DETAILS - Align base plate of each foot (A and B) in the undersides of the sofa as shown in the below diagram. Insert Screw (C) and tighten by turning clockwise using screwdriver

PART I

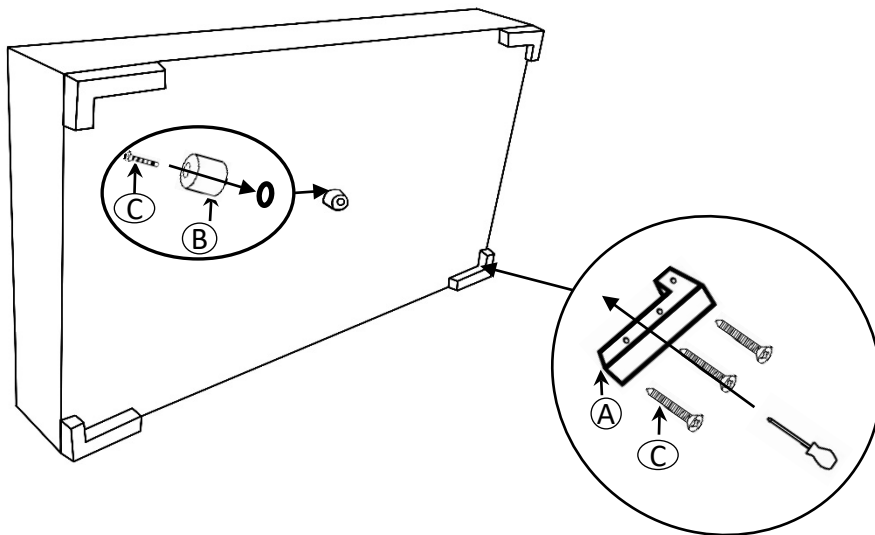

Step 2 PART I ASSEMBLY COMPLETED

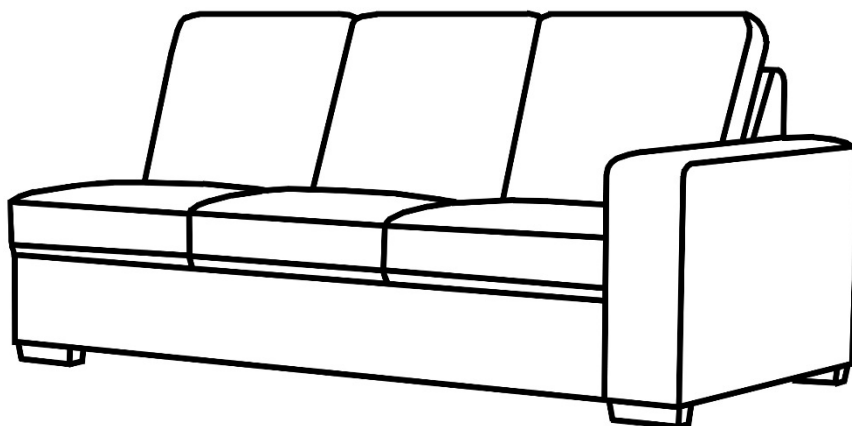

Step 3

With 2 people carefully turn lounge over onto a sheet or a piece of cardboard.

DETAILS - Align base plate of each foot (A and B) in the undersides of the sofa as shown in the below diagram. Insert Screw (C) and tighten by turning clockwise using screwdriver

PART II

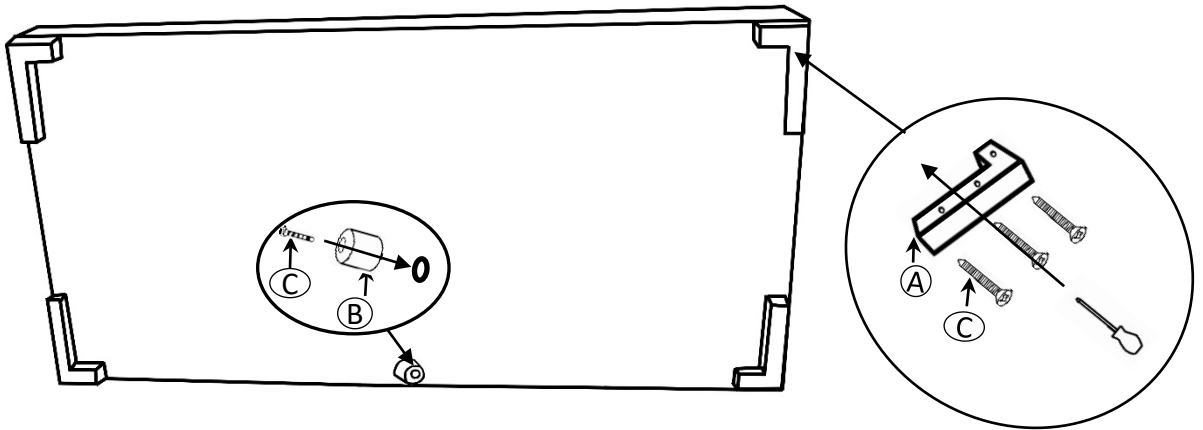

Step 4 PART II ASSEMBLY COMPLETED

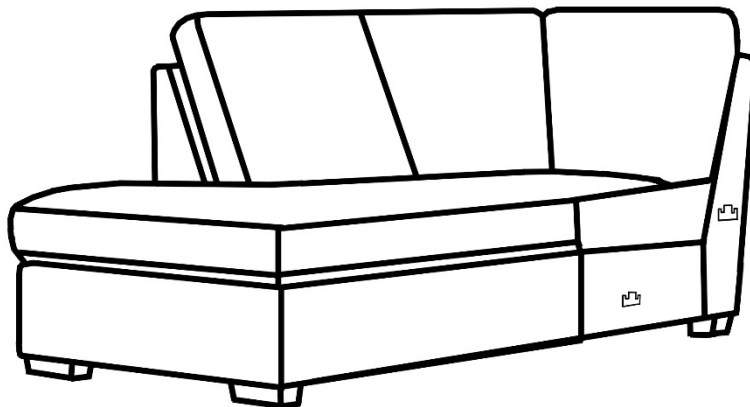

Step 5 ASSEMBLY COMPLETED

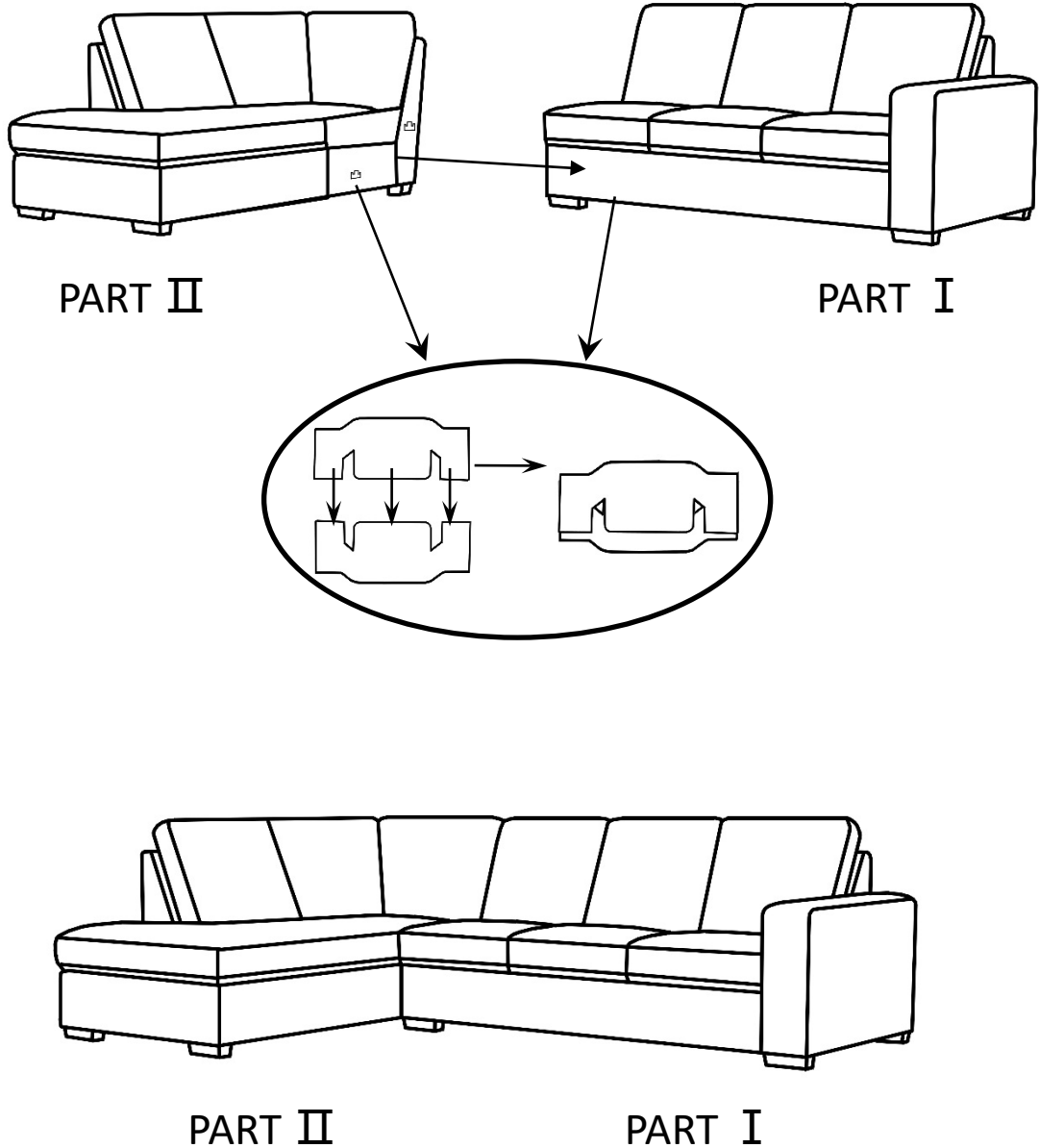

IMPORTANT:
PLEASE ENSURE FEET ARE TIGHTENED SECURELY BEFORE USE!

CARE LABEL

FABRIC CARE

REGULAR CARE: PROTECT FROM DIRECT SUNLIGHT.
VACUUM REGULARLY USING LOW SUCTION.
ROTATE REVERSIBLE CUSHIONS REGULARLY.

CLEANING:

DO NOT REMOVE CUSHION COVERS FOR SEPARATE
CLEANING EVEN THOUGH THEY HAVE ZIPPERS.
DO NOT WASH
DO NOT DRY CLEAN
DO NOT SHAMPOO CLEAN
CLEAN WITH HOT-WATER EXTRACTION MACHINE.
(HOT) PROFESSIONAL CLEANING RECOMMENDED
DO NOT USE DISHWASHING OR LAUNDRY
DETERGENTS
USE ONLY UPHOLSTERY DETERGENTS
DO NOT WET FILLING
DRY IN SHADE AWAY FROM DIRECT HEAT AND
SUNLIGHT
ALLOW TO DRY THOROUGHLY BEFORE RE-USE

SPOT CLEANING:

DO NOT RUB
DO NOT SPOT CLEAN WITH ANY SOLVENT.
TREAT SPILLS AND STAINS AS SOON AS POSSIBLE.
GENTLY SCRAPE ANY SOIL OR MOP ANY LIQUID
FROM THE SURFACE OF THE FABRIC.
APPLY PROPRIETARY CLEANING AGENTS STRICTLY
ACCORDING TO INSTRUCTIONS TO REMOVE THE
RESIDUE OF THE SPILL.
DO NOT SATURATE THE FABRIC OR INTERIOR WITH
WATER OR OTHER CLEANING LIQUIDS.

WARNING: APPLY ONLY WATER-BASED SOIL RESIST
(FABRIC PROTECTION) TREATMENTS. DO NOT USE
AEROSOL PRODUCTS.