

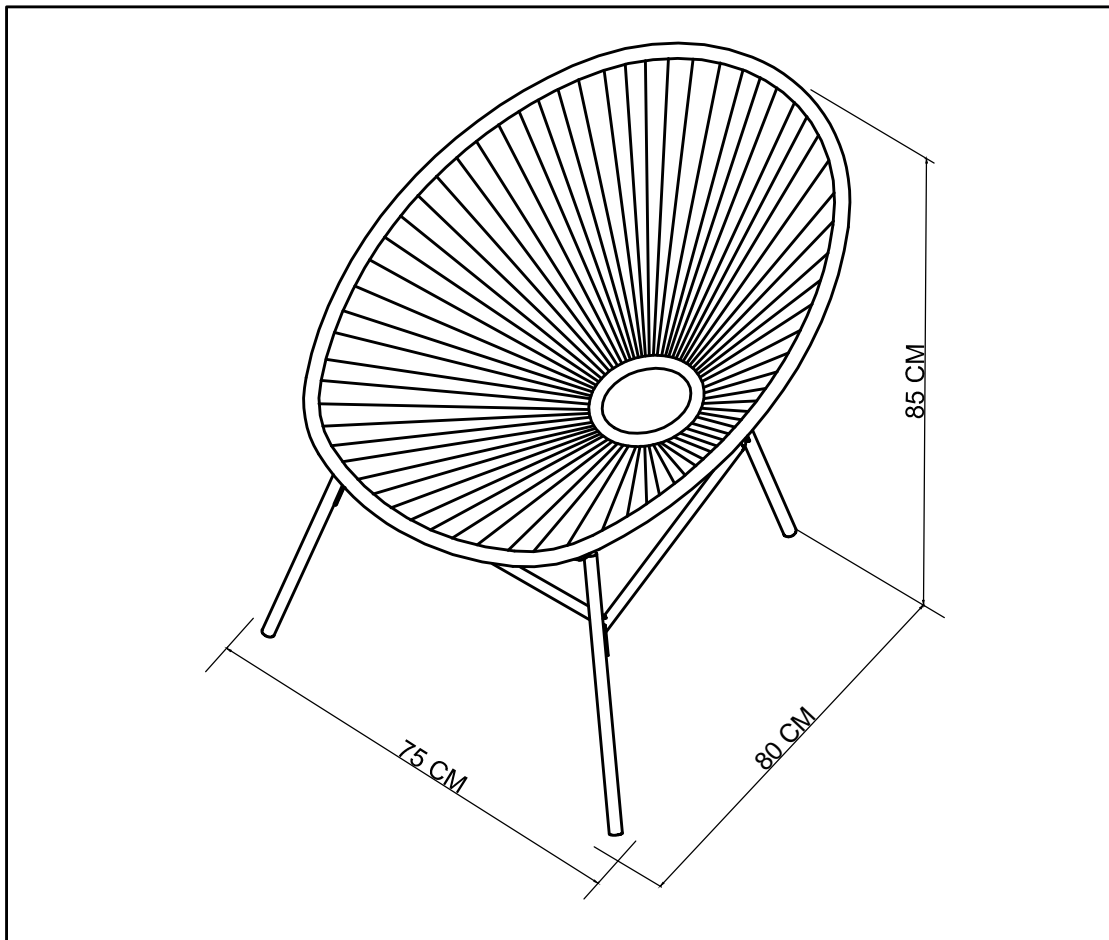

ASSEMBLY INSTRUCTION  
JOY OUTDOOR SUN CHAIR  
ITEM CODE - 59564

Imported by Amart Furniture Pty Ltd, Qld, Brisbane Australia .  
For any assistance with assembly or for missing parts please phone  
Amart Furniture Ewing road, Customer Service Freecall 1800 009 466



Imported by Amart Furniture Pty Ltd, Qld, Brisbane Australia .  
For any assistance with assembly or for missing parts please phone  
Amart Furniture Ewing road, Customer Service Freecall 1800 009 466

## PRE-ASSEMBLY PREPARATION



### Before you start:

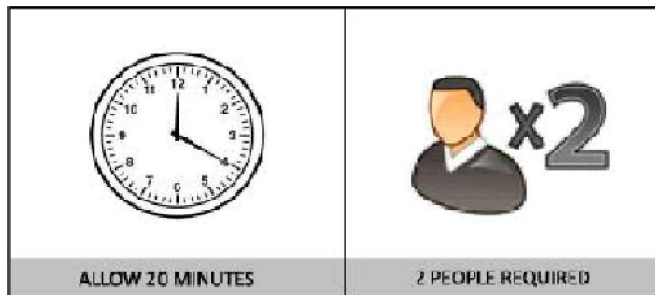

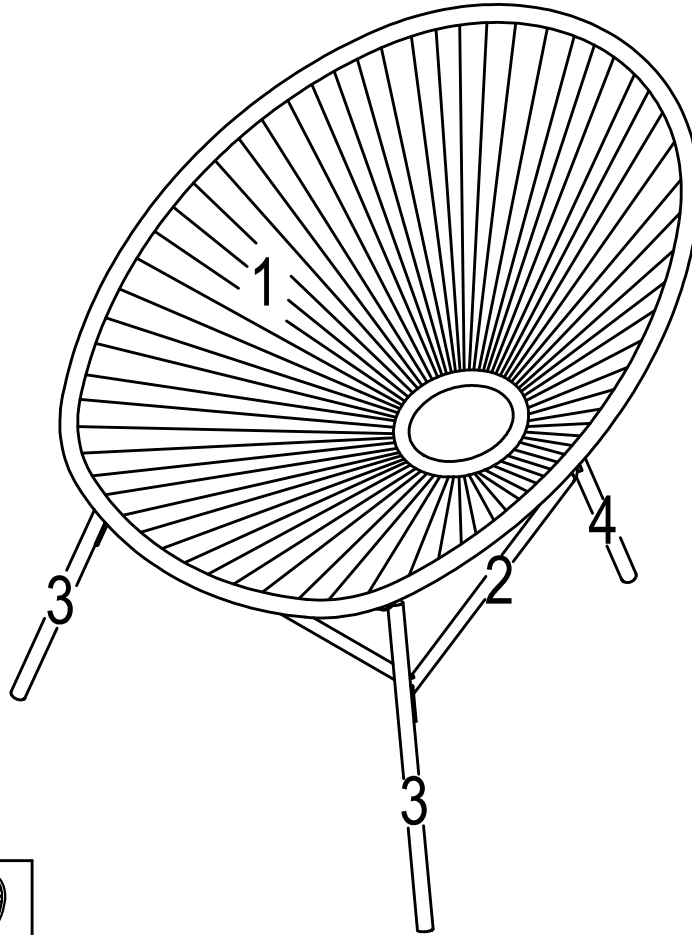

1. Choose a clean, level, spacious assembly area. Avoid hard surfaces that may damage the product.
2. Take care when lifting. Product should be assembled as near as possible to the point of use.
3. Ensure that you have all required contents for complete assembly.
4. Always read the assembly instructions carefully before beginning assembly.
5. Keep all hardware parts and packaging out of reach of small children.
6. Do not over tighten the screws and bolts as this may damage the threads.

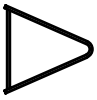

# PARTS LIST

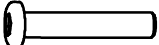

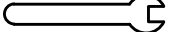





1. Seat	
2. Triangle base	
3. Short Legs x2	
4. Long Leg	

A. Cambered Washer  M6*3PCS	B. Bolt  M6*30L*9PCS	C. Nut  M6*6PCS	D. Washer  M6*6PCS	E. Wrench  M6*1PC	F. Hexagan Key  M6*1PC
--	---	--	---	--	---

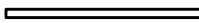
# Step 1:

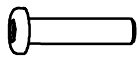
## ITEMS REQUIRED

1. Seat 1PC 	3. Short Leg 2PCS 	4. Long Leg 1PC 
A. Cambered Washer M6*3PCS 	B. Bolt M6*30L*3PCS 	F. Hexagan Key M6*1PC 



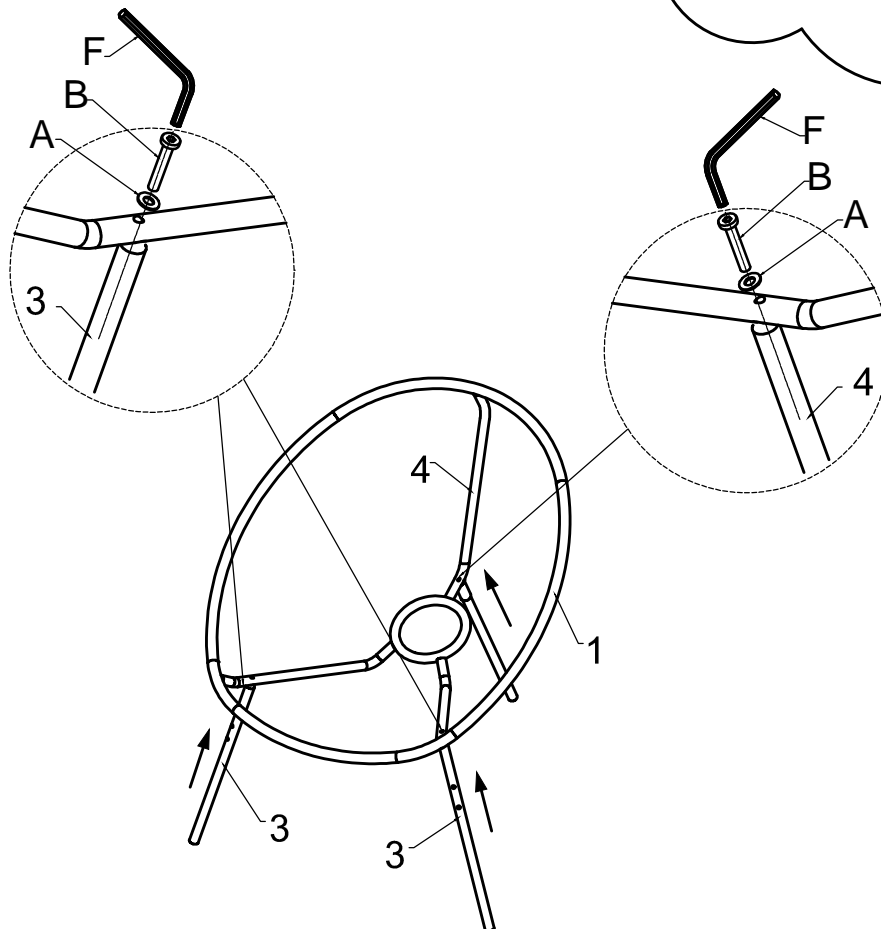

- Insert the legs into the Seat back .
- Attach Short Leg (3) and Long Leg (4) to Seat (1) using Bolt (B) Cambered Washer (A) as shown in the below diagram .
- Tighten with Hexagan Key ( F ) .

Important :  
Please DO NOT fully tighten any screws until you finish the assembly.

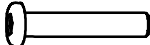

# Step 2:

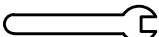
## ITEMS REQUIRED

2. Triangle base 1PC 	B. Bolt M6*30L*6PCS 	C. Nut M6*6PCS 
D. Washer M6*6PCS 	E. Wrench M6*1PC 	F. Hexagan Key M6*1PC 

- Attach Triangle base (2) to Legs (3 & 4) using Bolt (B) Washer (D) and Nut (C) as shown in the below diagram .
- Tighten with Wrench ( E ) and Hexagan Key ( F ) .

Important :  
Once the base is attached ,  
fully tighten all bolts.  
Be careful not to over tighten  
as this may cause the bolts to thread.

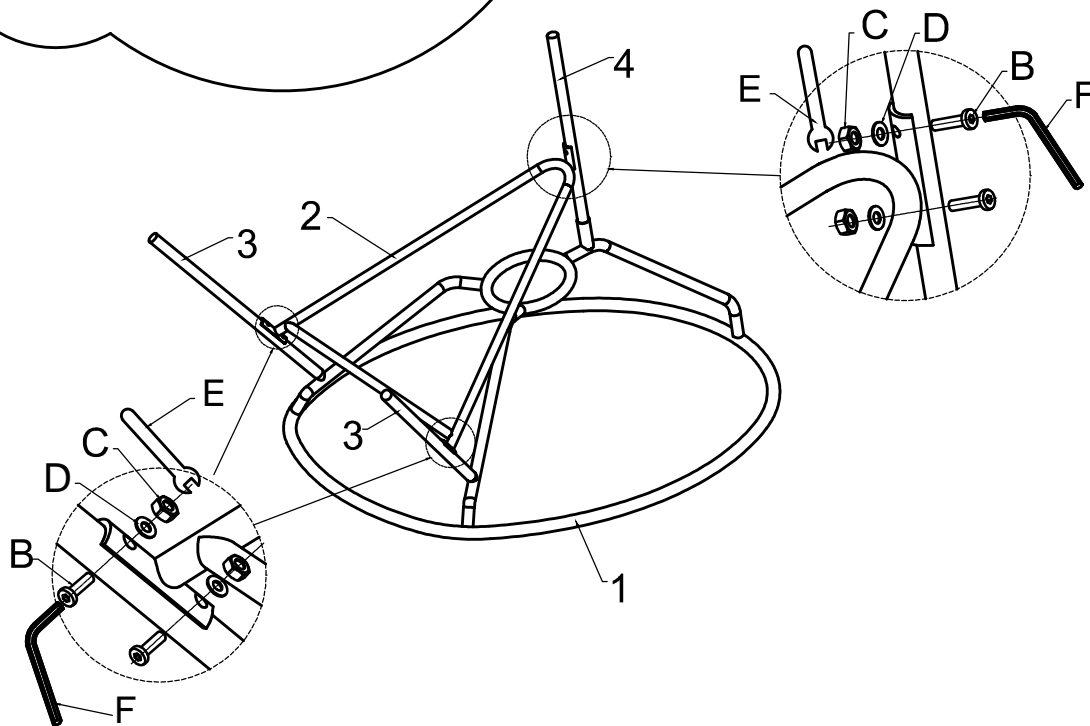

**ASSEMBLY IS COMPLETE**

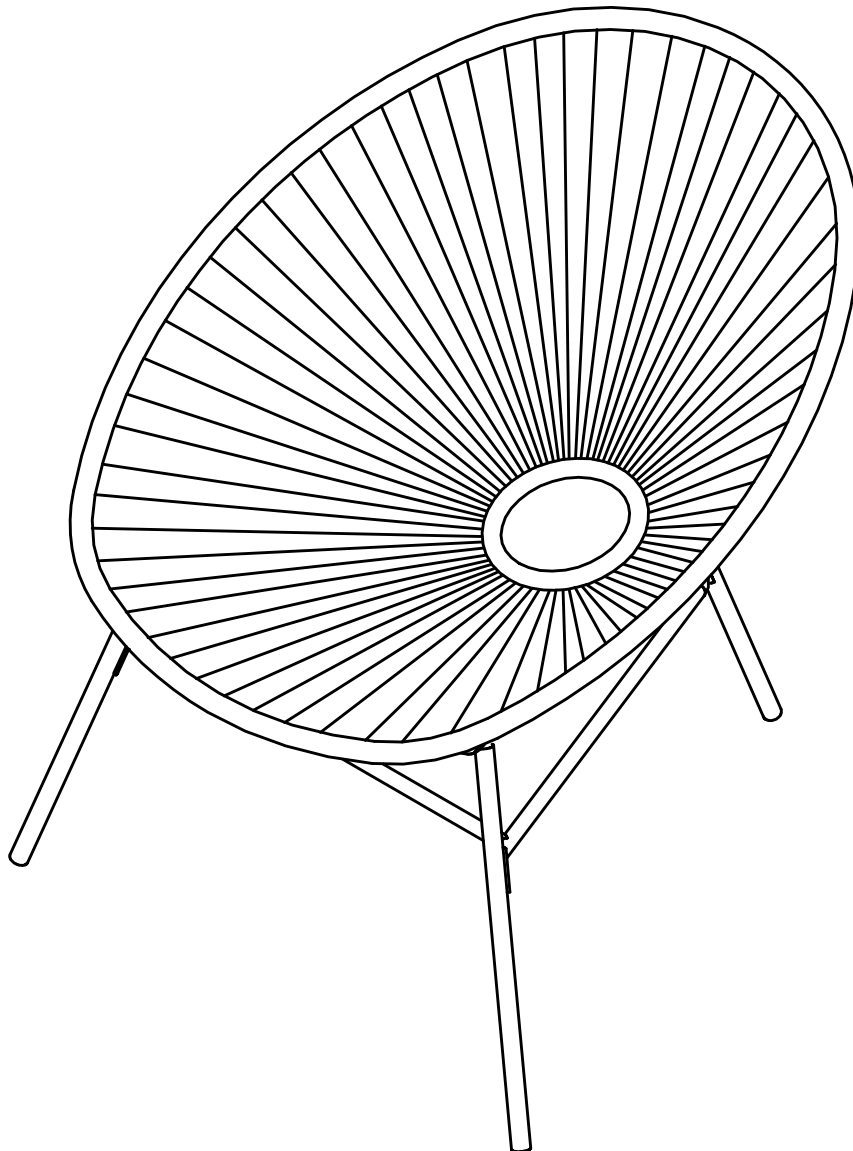

# Care and maintenance



---

## Cushions

- Direct exposure to the sun's harmful UV rays is likely to cause rapid colour fading to fabrics.
- To ensure product longevity it is recommended outdoor products are not left permanently exposed to the elements.

## Timbers

- Prolonged exposure of timber items to the elements may cause premature deterioration.
- Regular vacuuming and dusting of items is recommended.
- Timber needs regular oiling -please contact store of purchase for further details.
- Minor cracking of timber is a natural process and will not compromise the strength of the timber.

## Wicker

- Regular vacuuming and dusting of items is recommended.
- If weave on wicker becomes lacerated/damaged, Do not pull on as this may cause unravelling.
- Prolonged exposure to the elements may cause colour fading.