

ASSEMBLY INSTRUCTION

CAPTAIN JACK DOUBLE BED

ITEM CODE : 80707

Imported by Amart Furniture Pty Ltd, Qld, Brisbane Australia.
For any assistance with assembly or for missing parts please phone
Amart Furniture Pty Ltd Customer Service Free call 1800 351 084

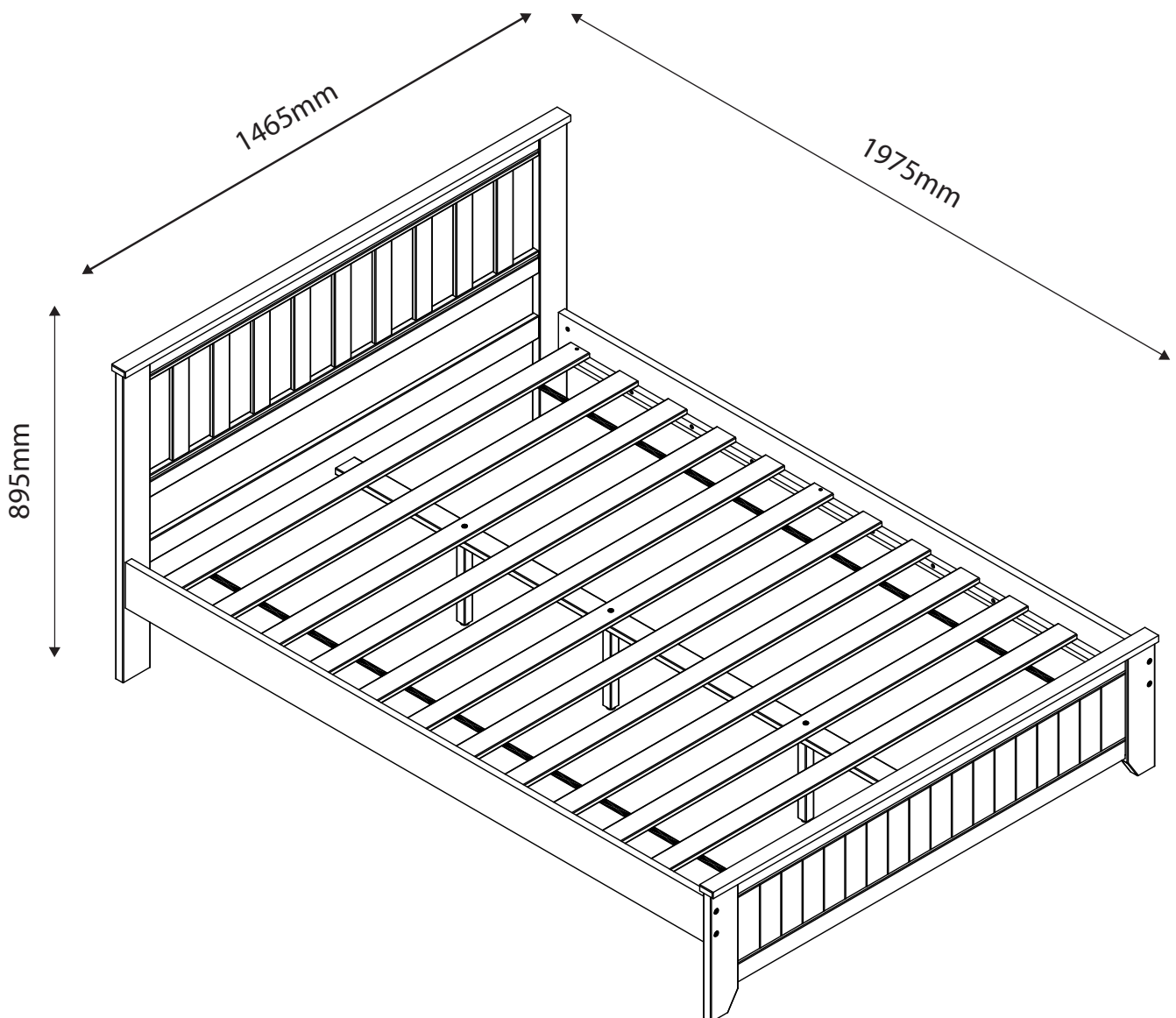





Imported by Amart Furniture Pty Ltd, Qld, Brisbane Australia.
For any assistance with assembly or for missing parts please phone
Amart Furniture Pty Ltd, Customer Service Free call 1800 351 084

PRE-ASSEMBLY PREPARATION

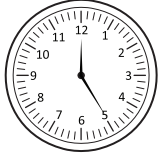
Before you start:

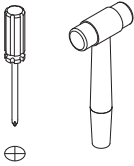
1. Choose a clean, level, spacious assembly area. Avoid hard surfaces that may damage the product.
2. Take care when lifting. Product should be assembled as near as possible to the point of use.
3. Ensure that you have all required contents for complete assembly.
4. Always read the assembly instructions carefully before beginning assembly.
5. Keep all hardware parts and packaging out of reach of small children.
6. Do not over tighten the screws and bolts as this may damage the threads.
7. Do not use power drills and drivers for tighten the screws and bolts as this may damage the item.

	
ALLOW 25 MINUTES	2 PERSON REQUIRED
	
ADDITIONAL TOOLS REQUIRED	NO POWER DRILL

PART LIST

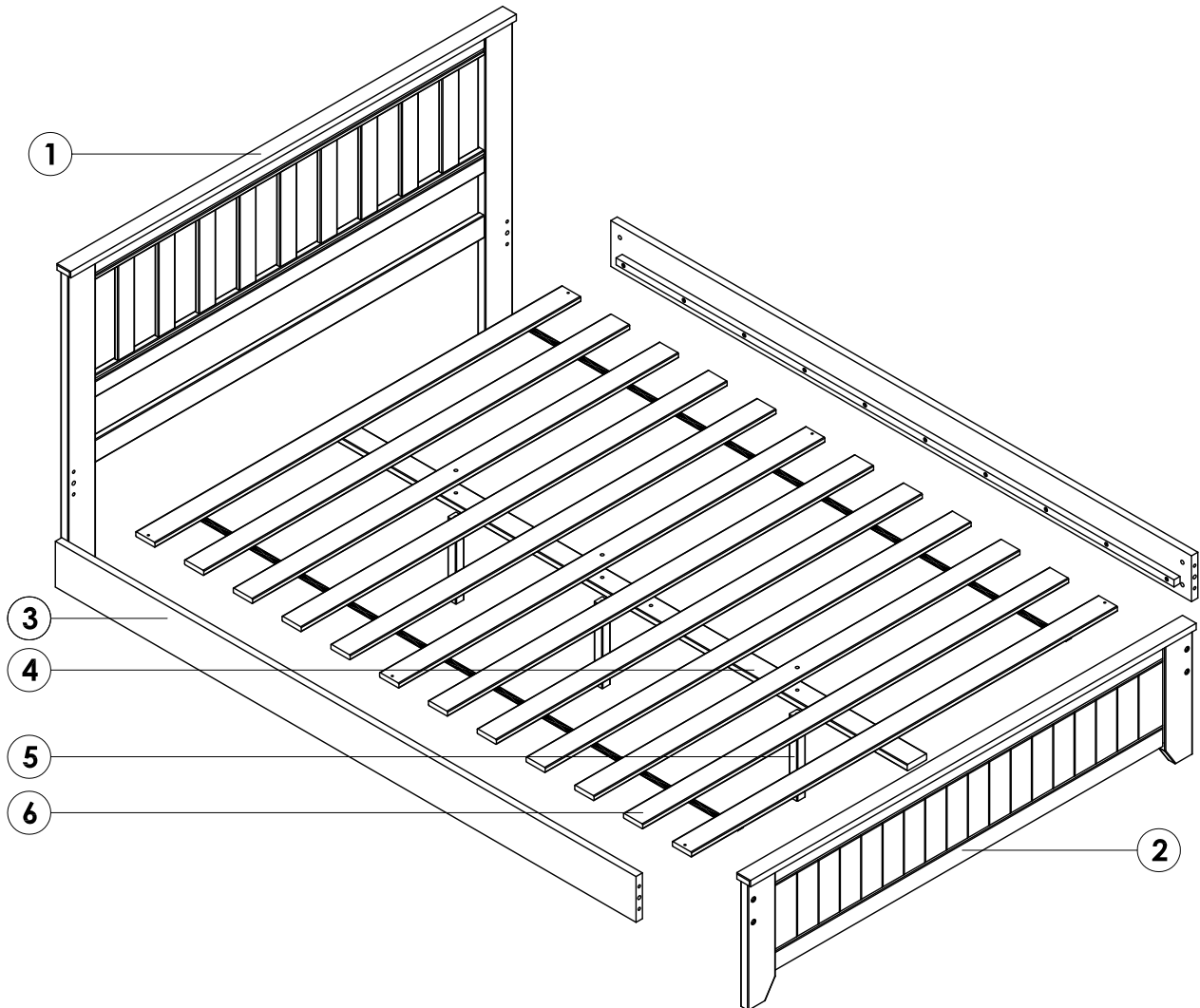

1	HEADBOARD	(X1)	4	CENTER SUPPORT	(X1)
2	FOOTBOARD	(X1)	5	SUPPORT LEG	(X3)
3	SIDE RAIL	(X2)	6	WOODEN SLAT (63 x 1397 = 12)	(X1)

HARDWARE LIST

A. PLASTIC DOWEL (M10 x 35MM)

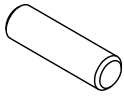

4 PCS

B. JCBC BOLT (M6 x 60MM)

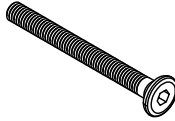

11 PCS

C. JRN NUT (M6 x 13MM)



8 PCS

D. CSK C/B SCREW (M4 x 32MM)

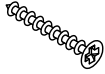

6 PCS

E. BASE GLIDE L190 (M6 x 23MM)

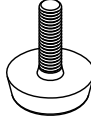

3 PCS

F. ALLEN KEY (M4 x 60MM)

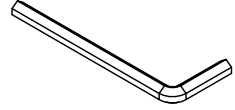

1 PC

STEP 1

Insert **Dowels (A)** into $\varnothing 10\text{MM}$ holes on **Side Rails** by using a Rubber Hammer.

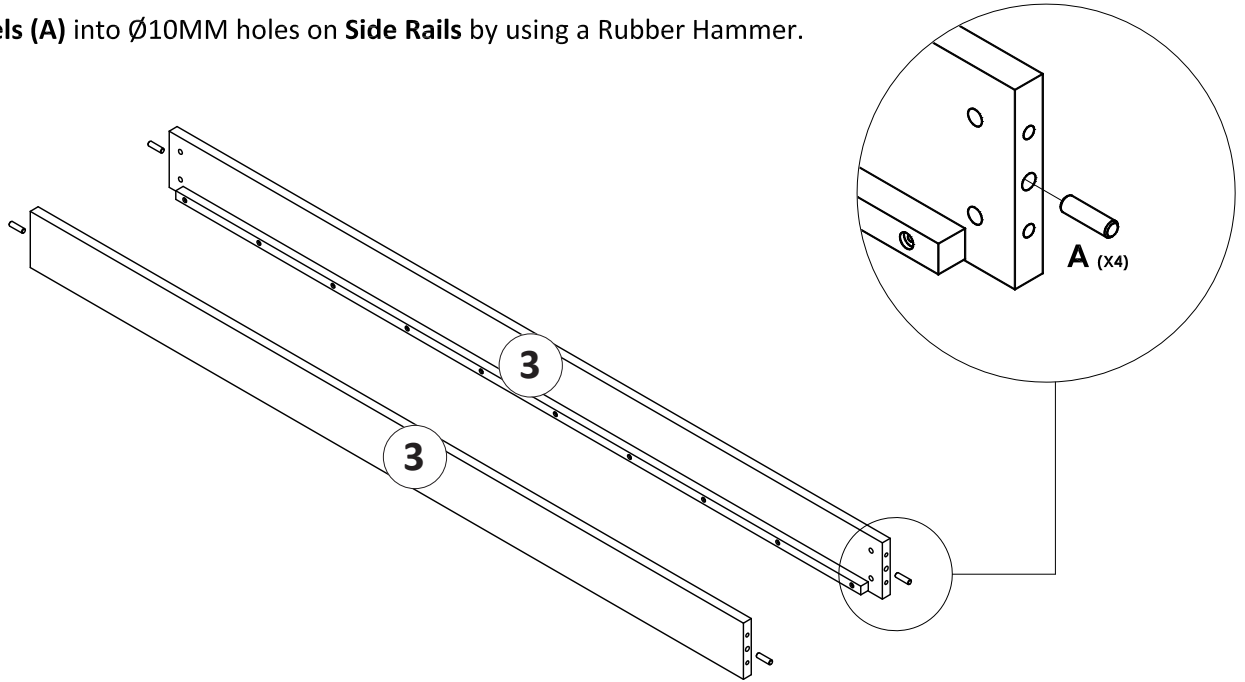

STEP 2

Attach **Side Rails** to **Headboard & Footboard** by using **Bolts (B)** and **Nuts (C)**, tighten it up by using an **Allen Key (F)**.

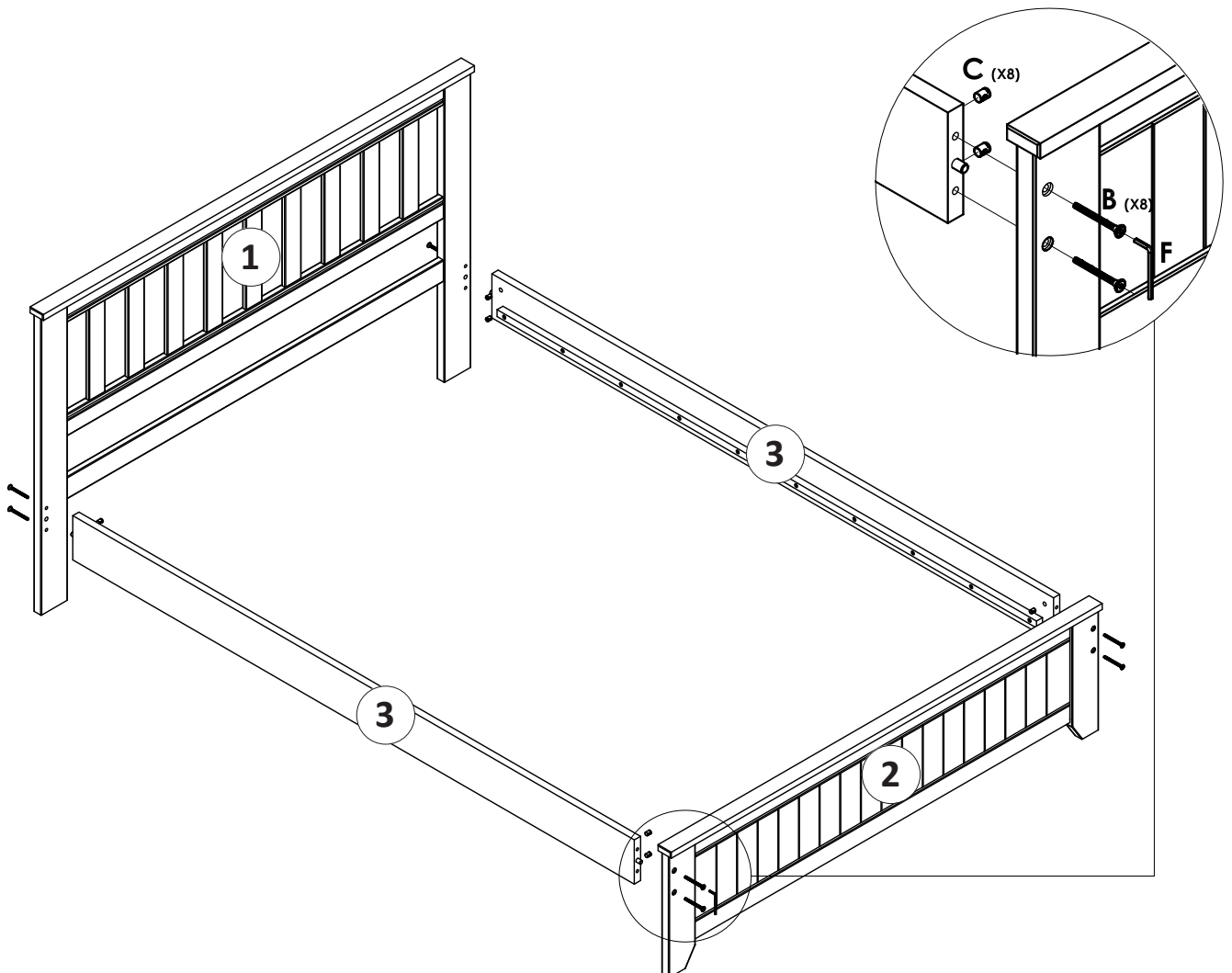

STEP 3

Screw **Base Glides (E)** under **Support Legs**.

Position **Center Support** and **Support Leg** under the middle of Bed.

Secure **Wooden Slat** onto **Center Support** and **Support Leg** by using **Bolts (B)**, tighten it up by using **Allen Key (F)**.

Secure **Wooden Slat** using **Screws (D)** into pre-drilled holes on both ends by using a Crosshead Screw Driver. Go on to complete the **Assembly**.

** Align both **Side Rail** before tightening the screws.*

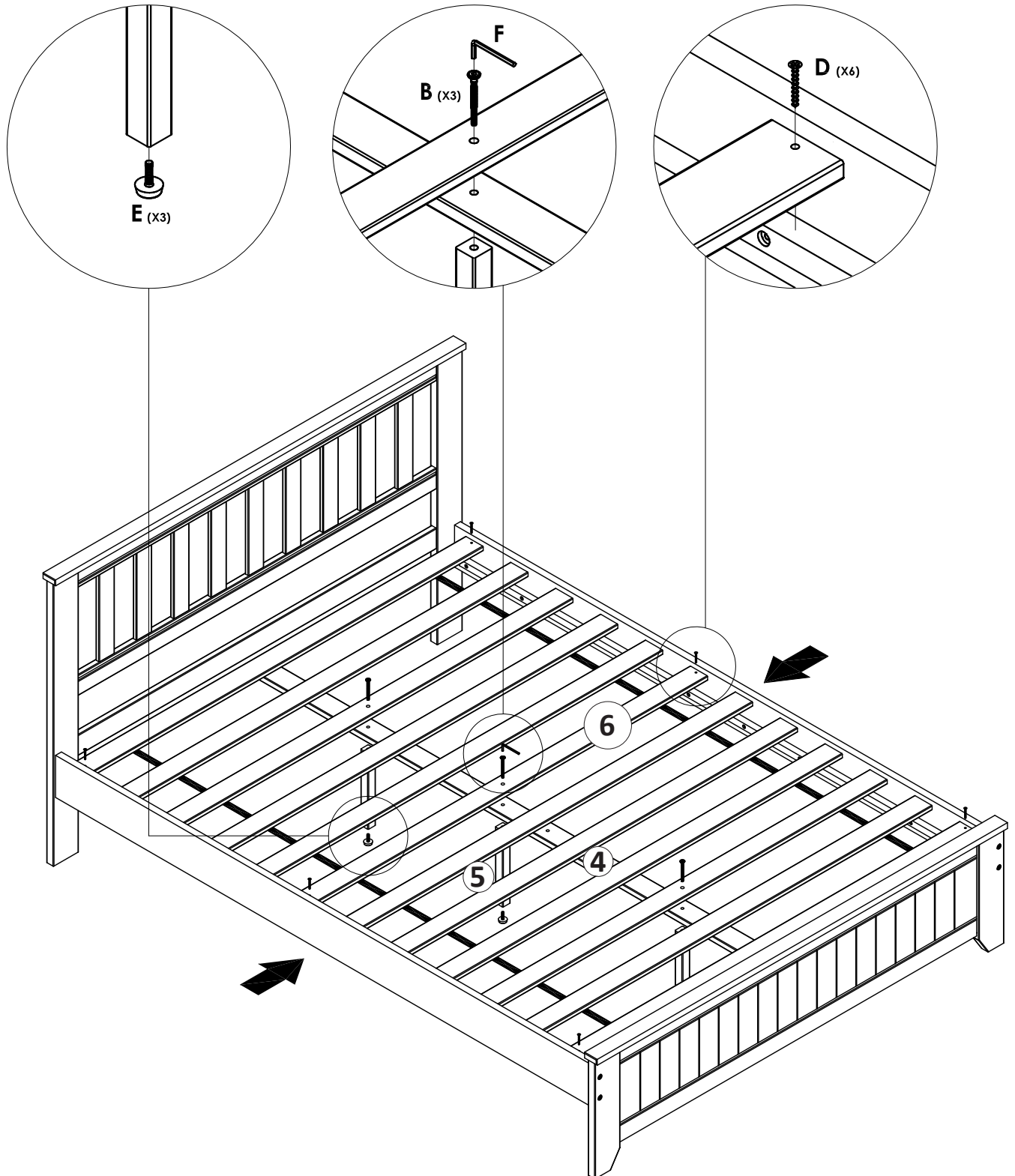

ASSEMBLY IS COMPLETE

CAUTION

ALWAYS LIFT YOUR BED WHEN MOVING/RELOCATING-DO NOT DRAG.
DRAGGING CAN CAUSE DAMAGE TO THE BED

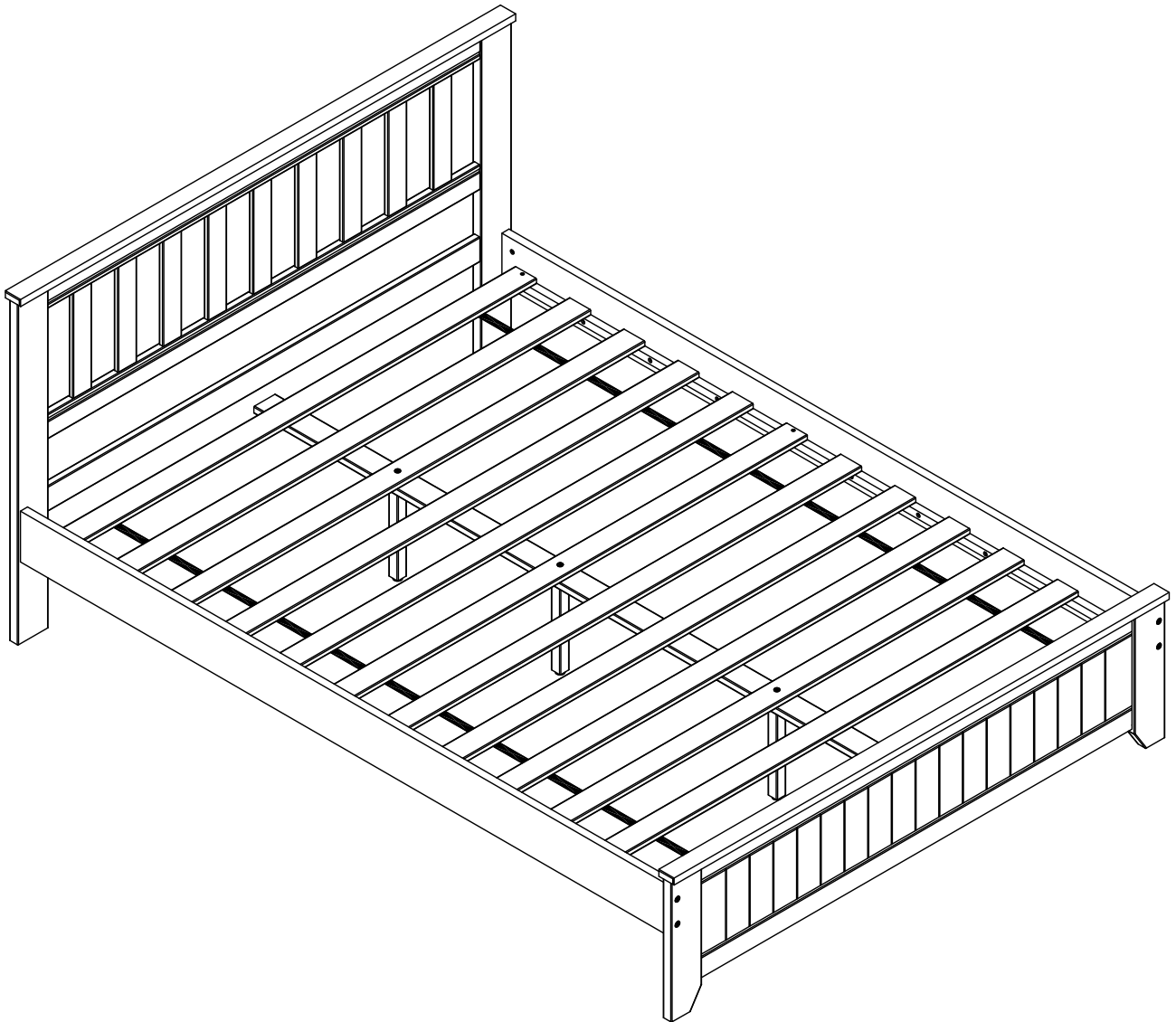

IMPORTANT : PRODUCT CARE FOR TIMBER ITEMS

As our timber is supplied from sustainable forests there will be natural variations in surface texture and grain like knots, mineral streaks and sap runs that may affect the finish. These differences in character are not defects, but distinctions that make each piece of furniture unique.

Our furniture is built to last. Following these steps for basic care should protect your investment for years to come.

- Dust frequently with a clean damp lint-free cloth. This will help remove abrasive build up which can damage a finish over time.
- Do not place hot objects on any furniture surface. Always use a hot plate or placemat. Laminate and lacquer finishes on table tops provide added scratch and heat resistance to our furniture, but they can still be damaged without proper care.
- Avoid exposing your furniture to strong sunlight, heat outlet, open windows or dampness. Prolonged exposure to direct sunlight can fade the finish of your furniture, while extreme temperature and humidity changes can cause cracking or splitting.
- Do not expose your furniture to any liquids. Never allow water to sit on your furniture. Alcohol, nail polish and perfume are also dangerous as they will dissolve the lacquer finish on contact and may require professional repairs.
- Do not allow plastic to come in direct contact with your furniture. Chemicals in plastic of placemats etc. may soften and mark the finish if left in contact with the furniture for a period of time.