

# ASSEMBLY INSTRUCTION

PETERS  
5 Tier Bookcase

Item Code 81921

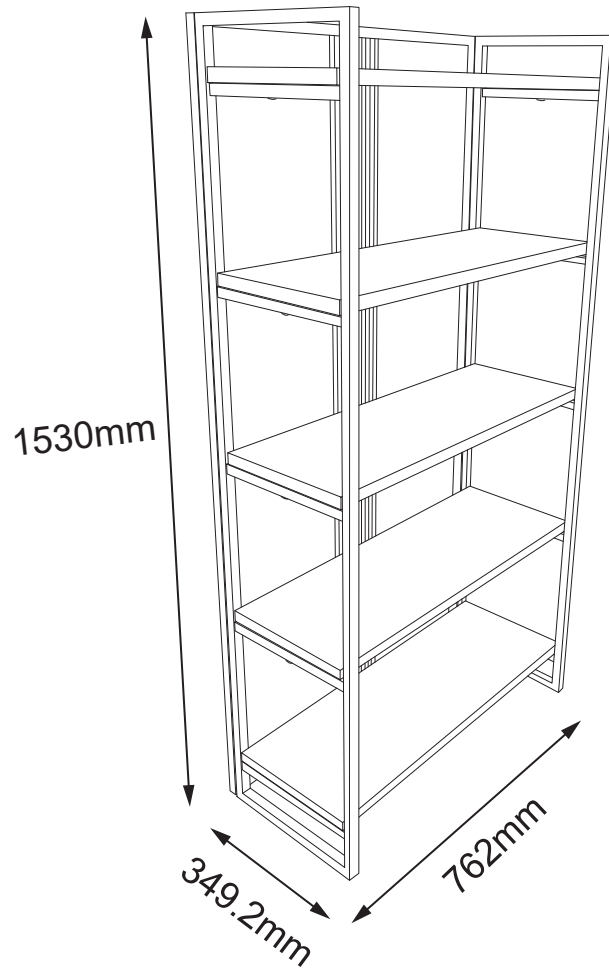



Imported by JWA Furniture Pty Ltd, Qld, Brisbane Australia.  
For any assistance with assembly or for missing parts please refer to your receipt

# PRE-ASSEMBLY PREPARATION

## Before you start:

1. Choose a clean, level, spacious assembly area. Avoid hard surfaces that may damage the product
2. Take care when lifting. Product should be assembled as near as possible to the point of use
3. Ensure that you have all required contents for complete assembly
4. Always read the assembly instructions carefully before beginning assembly.
5. Keep all hardware parts and packaging out of reach of small children.
6. Do not over tighten the screws and bolts as this may damage the threads
7. Assembly is to be carried out by a competent adult(s) ONLY
8. During assembly, children should be kept away from the product due to possible risk to injury.
9. Do not use this item if any components are missing or damaged.
10. Please keep the instructions for future reference.

	
Allow 30 min	For 1 person

## **TIPPING WARNING**



Serious or fatal injuries may occur from furniture toppling over. To help avoid this please follow the below recommendations:



- Install the provided "Tipping Kit" as per the instructions
- Never allow children to climb on or hang off of any part of this product
- Unless specifically designed to accommodate, do not set TVs or other heavy objects on top of this product

If this product has drawers:

- Place the heaviest items in lowest drawers
- Do not open more than 1 drawer at a time as this may cause the product to become unbalanced
- Do not tamper with or remove any drawer interlocking/running system

**Note:** The use of the provided "Tipping Kit" may reduce but not necessarily eliminate the risk of furniture toppling over. Please use this product with caution.

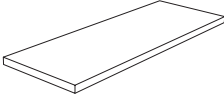
*This is a permanent label. Do not attempt to remove!*

PARTS LIST						HARDWARE LIST					
NO.	DESCRIPTION		QTY	NO.	DESCRIPTION		QTY	NO.	DESCRIPTION		QTY
①	leg		1	②	shelf		5	A	bolt		10
								B	allen key		1

### Step 1

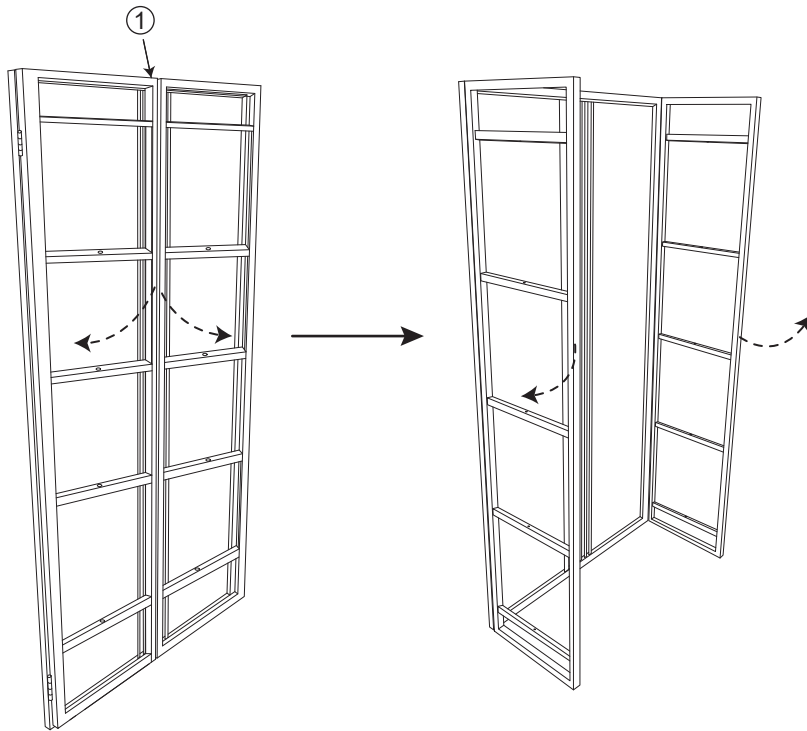

### Step 2

### Completion

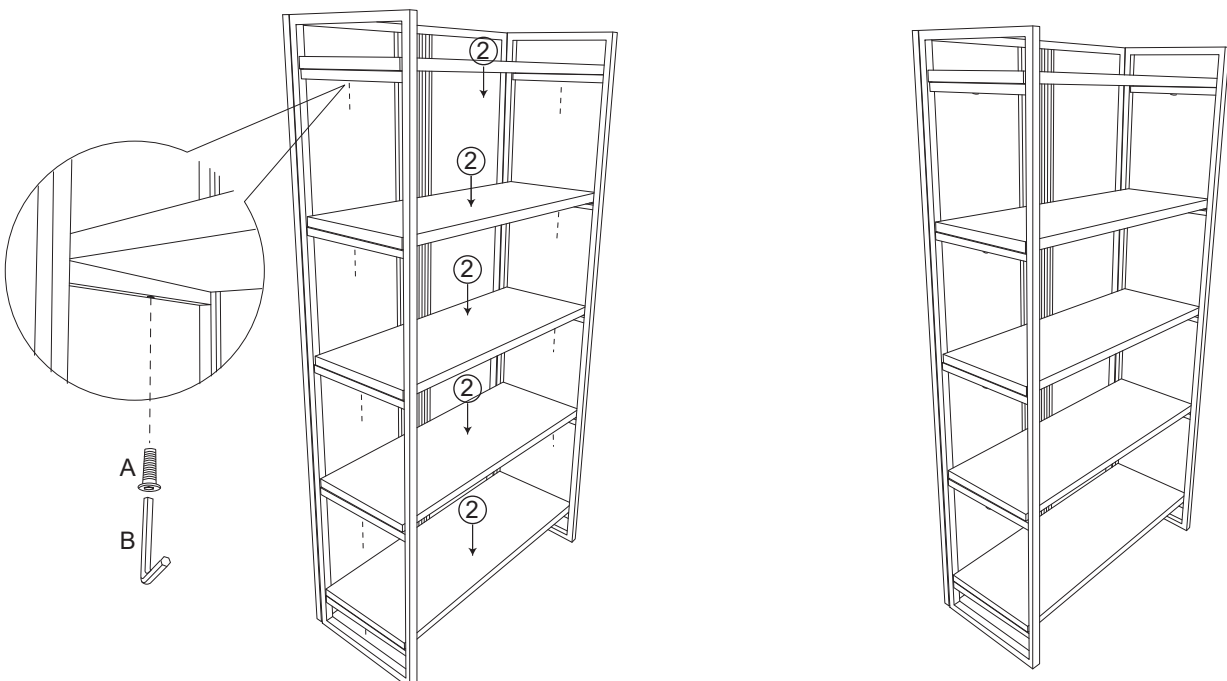

# SAFETY BRACKETS INSTRUCTIONS

1. Install Plastic Screw Anchor in the wall and attach one Mounting Plate to the anchors with the Large Screws. Make sure to attach the Mounting Plate into a stud.
2. Attach the second Mounting Plate to the furniture frame with the Short Screws.
3. Move the furniture to its final position. Thread a Wall Strap through the both Mounting Plates and tighten until snug. Do not over tighten.
4. Make sure that the Mounting Plates are firmly attached to the wall and furniture and that the Wall Strap is snug.
5. NOTE: Please adjust the installation mode of the safety bracket according to the actual situation.

## HARDWARE



Mounting Plate x 2



Wall Strap x 2



Plastic Screw Anchor x 2



Large Screw x 2

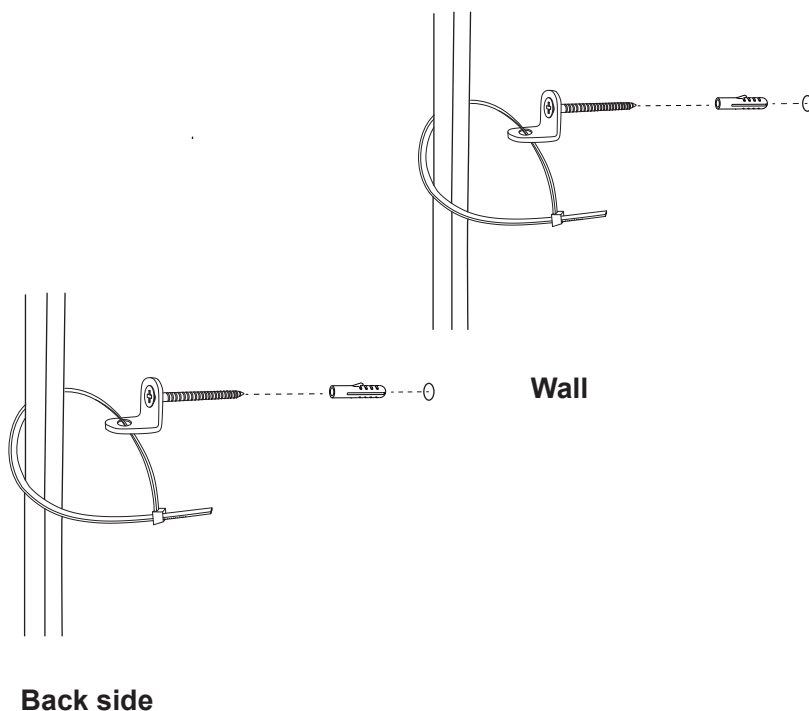

## PRODUCT CARE:

To protect your furniture, we suggest the following:

- Avoid placing your furniture in direct sunlight.
- Do not place furniture directly under windows.
- Do not place sharp objects (knife, fork, etc.) directly onto your furniture as sharp objects may scrape and damage the finish.
- Do not place hot objects directly onto the surface of your furniture.
- Clean up spills quickly. Water left over a prolonged period of time may cause damage. Alcohol, perfume, nail polishes, aftershave and some medication may cause severe finish damage if not cleaned immediately.
- Use a clean, soft, dry, lint free absorbent cloth to clean your furniture. Do not use any detergent as they may contain chemicals that may react and damage the finish.

NOTE: If the above care advise is not adhered to your product warranty may become void