



## ASSEMBLY INSTRUCTION

### MINKE STOOL

ITEM CODE 71720

Imported by Amart Furniture Pty Ltd, Qld, Brisbane Australia.

For any assistance with assembly or for missing parts please phone

Amart Furniture, Customer Service Free call 1800 351 084

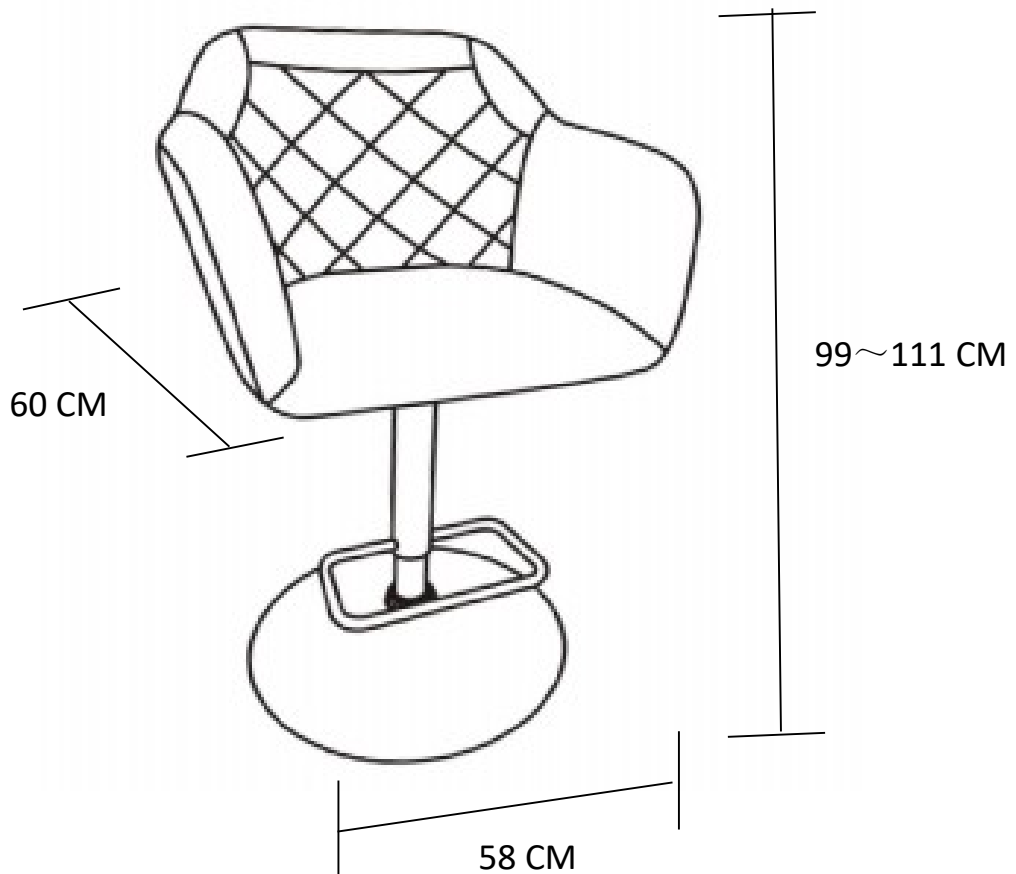

Imported by Amart Furniture Pty Ltd, Qld, Brisbane Australia.

For any assistance with assembly or for missing parts please phone  
Amart Furniture, Customer Service Free call 1800 351 084





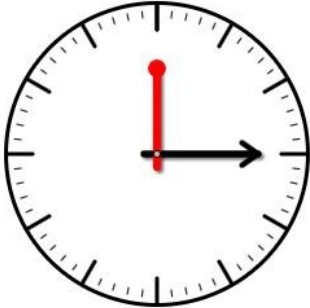
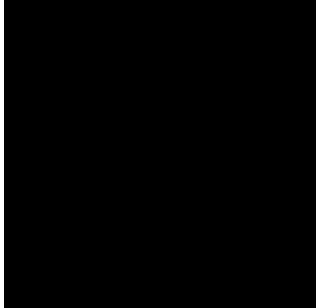

## PRE-ASSEMBLY PREPARATION

### Before you start:

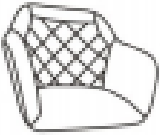
1. Choose a clean, level, spacious assembly area. Avoid hard surfaces that may damage the product
2. Take care when lifting. Product should be assembled as near as possible to the point of use
3. Ensure that you have all required contents for complete assembly
4. Always read the assembly instructions carefully before beginning assembly.
5. Keep all hardware parts and packaging out of reach of small children.
6. Do not over tighten the screws and bolts as this may damage the threads

	
Allow 15 min	For 1 person

# PARTS LIST

<b>A</b> 	<b>B</b> 	<b>C</b> 	<b>D</b> 
<b>E</b> 	<b>F</b> 	<b>G</b> 	

<b>A</b>	Seat*1pc	<b>B</b>	Foot Rest*1pc	<b>C</b>	Gaslift*1pc
<b>D</b>	Plastic ring*1pc	<b>E</b>	Base *1pc	<b>F</b>	Bolt *4pcs
<b>G</b>	Allen Key *1pc	<b>H</b>			



Step 1:

↑  Please pull out the sheath before using

Attach Gaslift (C) And Plastic ring (D) On Base (E)

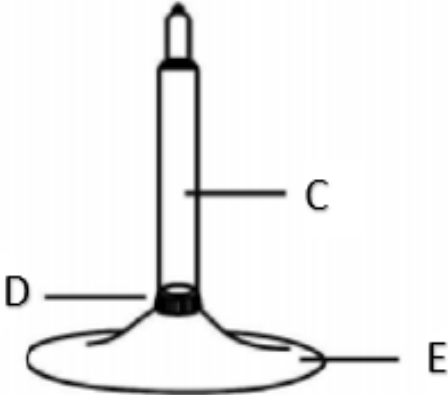

Step 2:

Attach Foot Rest (B) On Seat (A) With BOLT (F) By Using Allen Key (G)

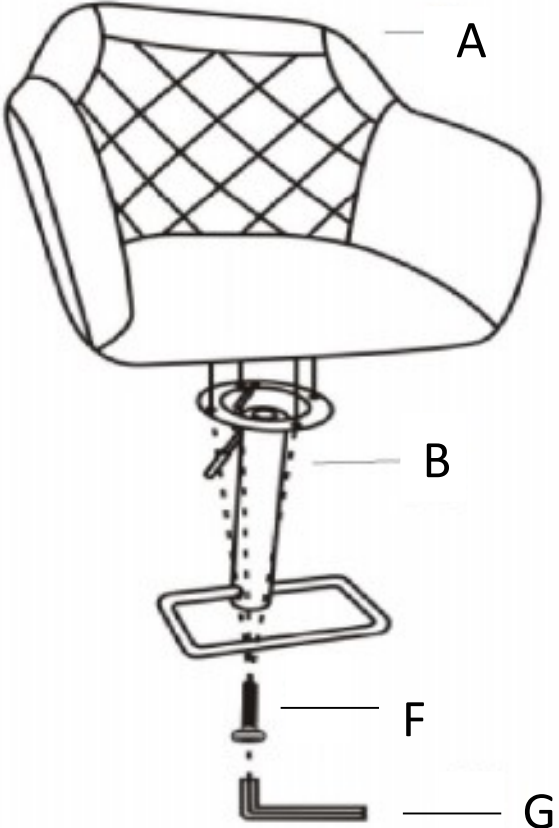

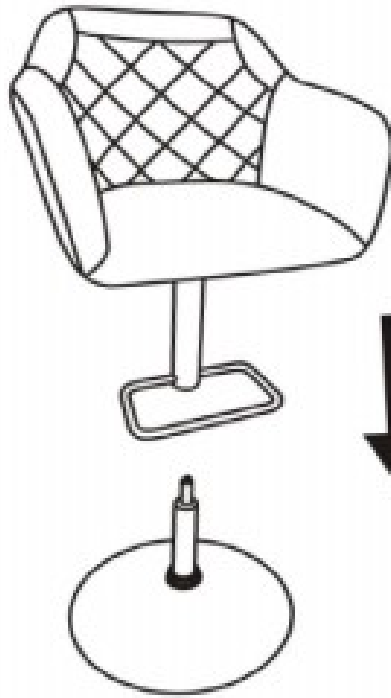

Lower part from Step ②  
onto part from Step ①



Assembly complete

## CARE AND MAINTENANCE

### REGULAR CARE:

- Protect from direct sunlight
- Vacuum regularly using low suction
- Rotate reversible cushions regularly
- Avoid exposure to new clothing, cushions or throws as this may lead to dye transfer and permanent staining

### CLEANING:

- Do not remove cushion covers for separate cleaning even though they may have zippers
- Do not wash, Do not dry clean, Do not shampoo clean
- Clean only with hot water extraction machine. Professional cleaning recommended
- Do not use dishwashing liquid or laundry detergent. Use only upholstery detergents
- Do not wet filling
- Dry in shade away from direct heat and sunlight
- Allow to dry thoroughly before re-use

### SPOT CLEANING:

- Do not rub
- Do not spot clean with any solvent
- Treat spills and stains as soon as possible
- Gently scrape off any soil or blot any liquid from the surface of the fabric before applying cleaner
- Apply proprietary cleaning agents strictly according to instructions to remove the residue of the spill
- Do not saturate the fabric or interior with water or other cleaning liquids

### WARNING:

Apply only water-based soil resist (fabric protection) treatments. Do not use aerosol products

- \* PILLING IS NOT A FABRIC DEFECT OR FAULT AND IS NOT COVERED BY WARRANTY
- \* PILLING IS A NORMAL OCCURRENCE CAUSED BY WEAR AND TEAR AND DOES NOT AFFECT THE DURABILITY OR FUNCTIONALITY OF THE FABRIC AND IS EASILY REMOVED

### CHAIRS AND STOOLS

Do Not:

Use chair/stool as a ladder

Climb on the chair/stool

Stand on the foot-rest of the chair, as this could lead to the stool becoming unbalanced and overturning