

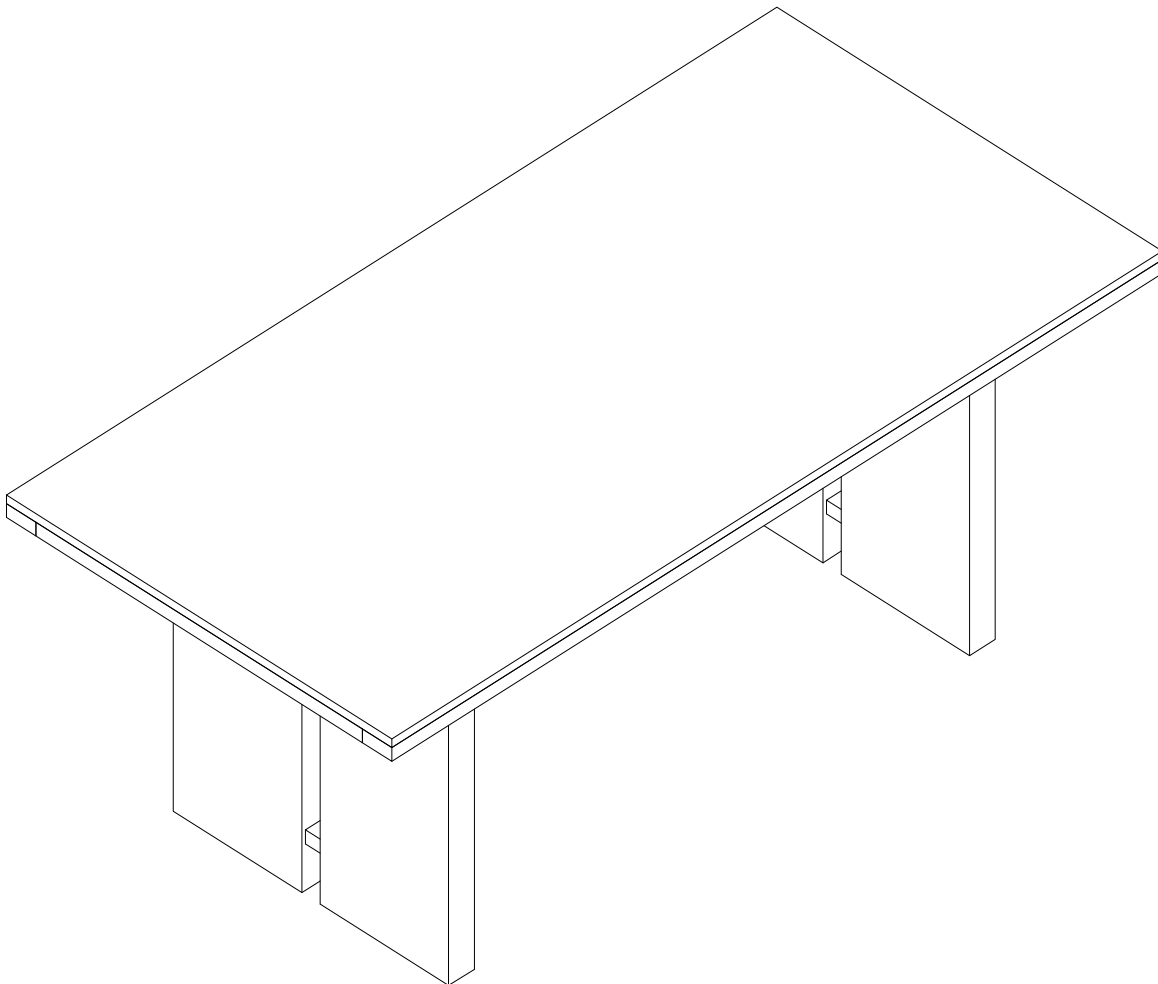

SIGNATURE
COLLECTION

ASSEMBLY INSTRUCTION
SORVINO DINING TABLE 2.1M
ITEM CODE - 63815

Imported by Amart Furniture Pty Ltd, Qld, Brisbane Australia.
for any assistance with assembly or for missing parts please phone
Amart Furniture, Customer Service Freecall 1800 351 084





Imported by Amart Furniture Pty Ltd, Qld, Brisbane Australia.
for any assistance to assembly or for missing parts please phone
Amart Furniture, Customer Service Freecall 1800 351 084

PRE-ASSEMBLY PREPARATION

BEFORE YOU START :

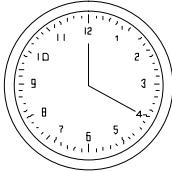

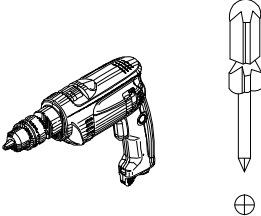
1. Choose a clean, level, spacious assembly area. Avoid hard surfaces that may damage the product
2. Take care when lifting. Product should be assembled as near as possible to the point of use
3. Ensure that you have all required contents for complete assembly
4. Always read the assembly instructions carefully before beginning assembly.
5. Keep all hardware parts and packaging out of reach of small children.
6. Do not over tighten the screws and bolts as this may damage the threads

	
ALLOW 20 MINUTES	2 PEOPLE REQUIRED
	<p>We recommend using screw driver to put this item together. However if you choose to use a power drill it must be used on LOW SPEED (LOW TORQUE) as too much pressure could damage the product.</p>
ADDITIONAL TOOLS REQUIRED	

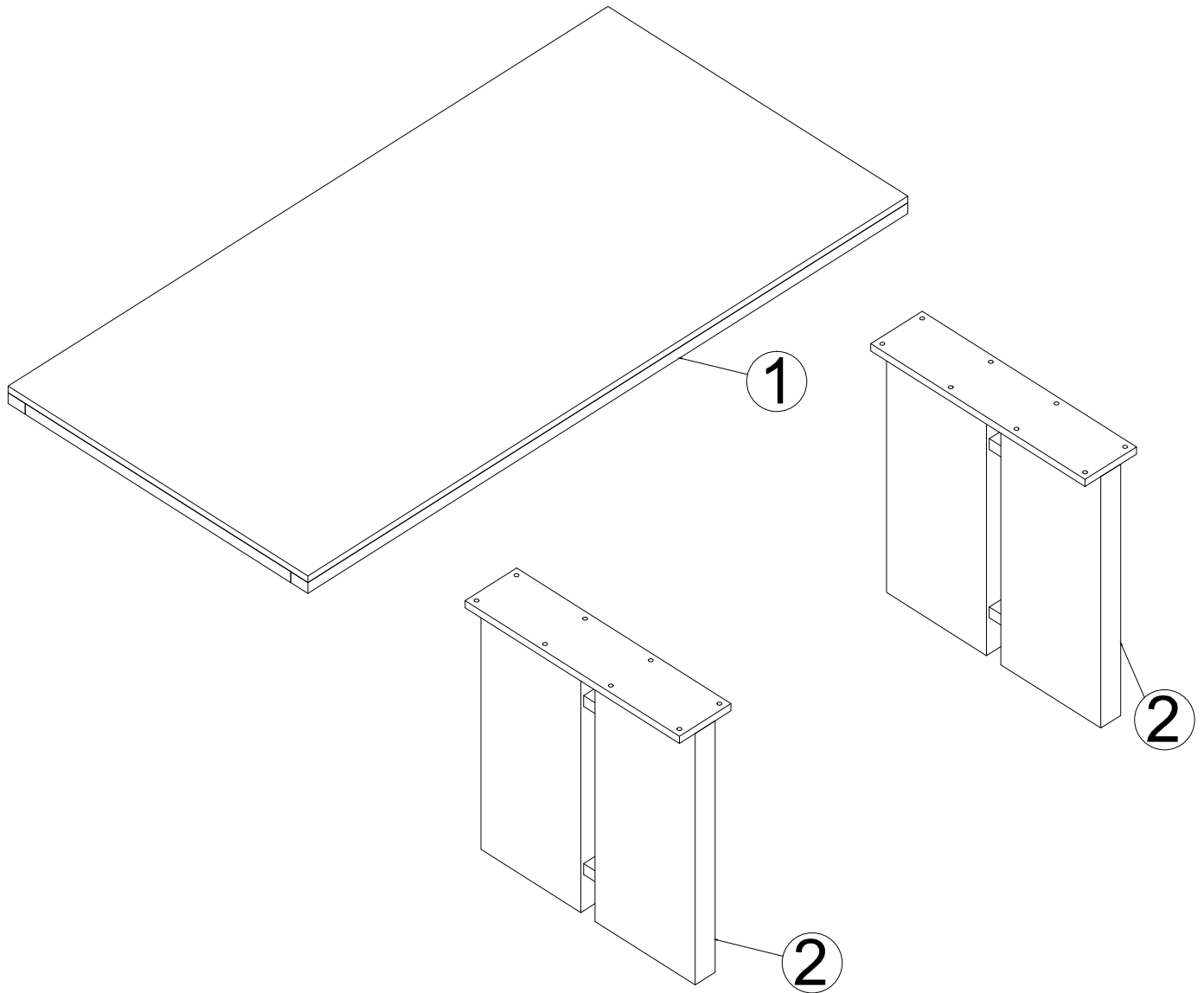
PARTS LIST

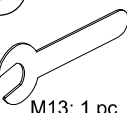

1	TOP	1PC
2	LEGS	2PCS

A BOLTS  M8x40: 16pcs	B WASHER  Ø8xØ19x1.2: 16pcs	C SPRING WASHER  Ø8xØ11x1.2: 16pcs	D SPANNAR  M13: 1 pc
---	---	--	--

Step 1 : Fasten the legs (2) To the top (1) with bolts (A), washer (B), spring washer (C) and using spannar (D)

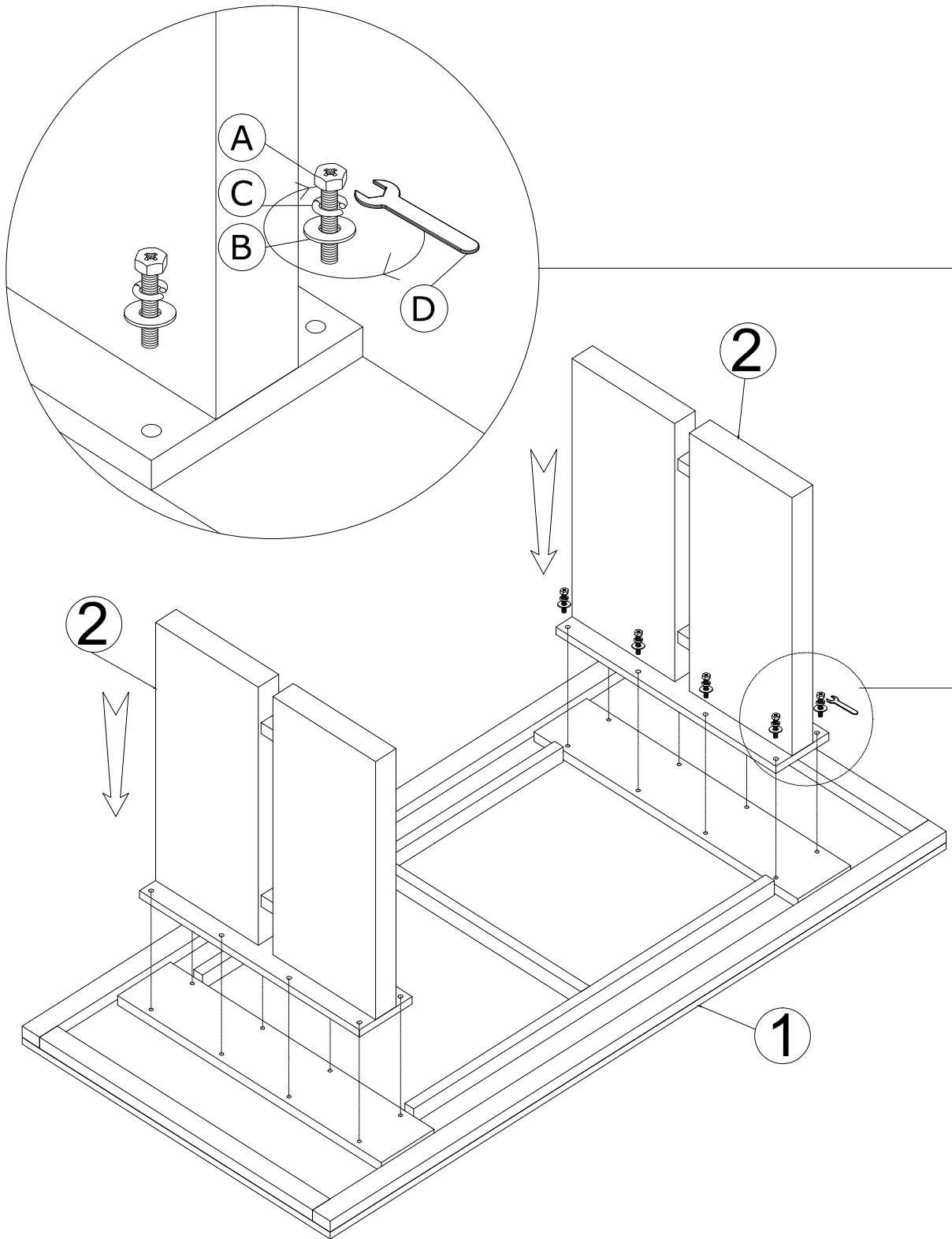

Note: Always use two people when turning the table over.

ASSEMBLY COMPLETE

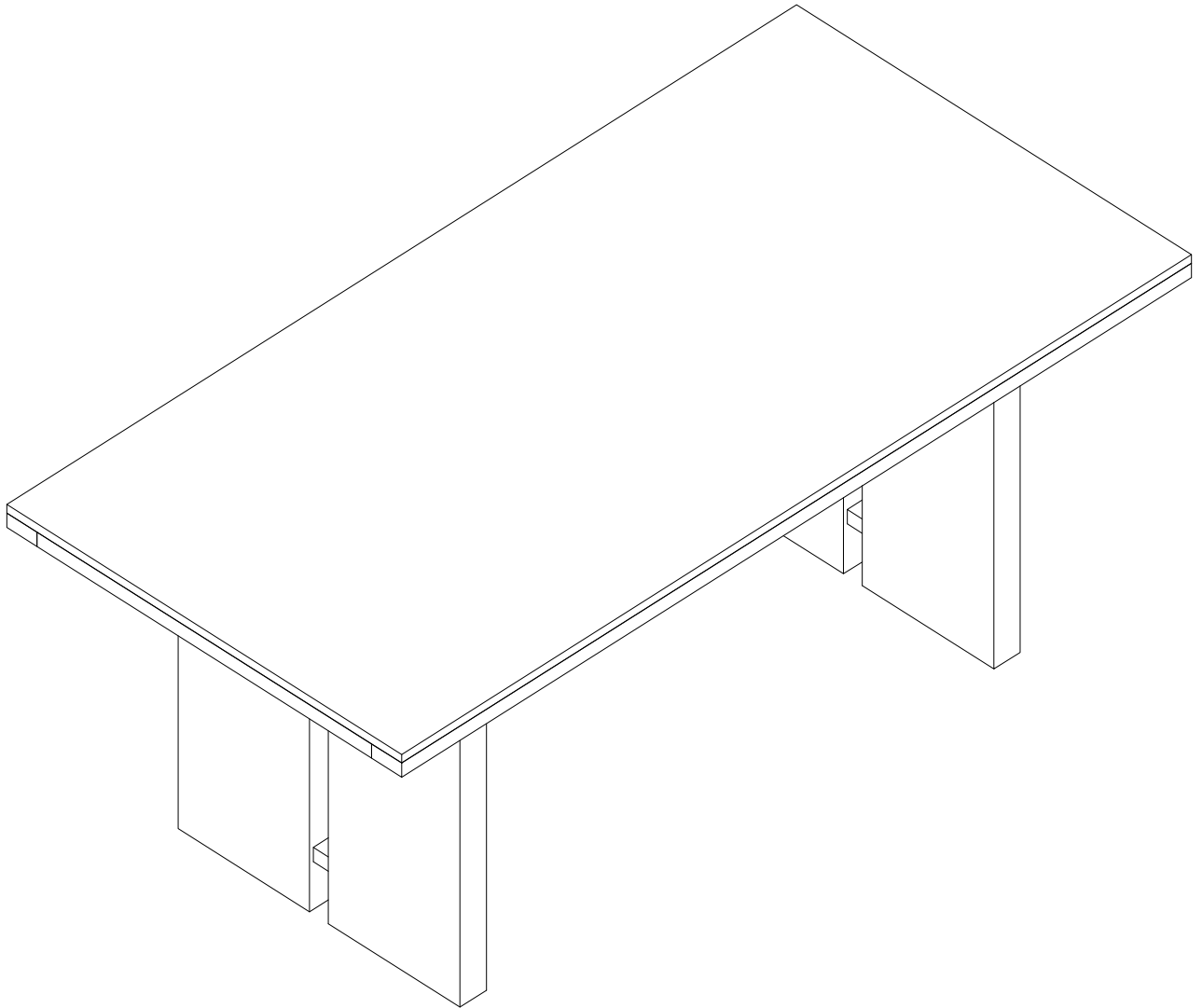



Product Name: **SORVINO DINING TABLE 2.1M**

Item Code: 63815

Product Care:

As your timber is supplied from sustainable forests there will be natural variations in surface texture and grain like knots, mineral streaks and sap runs that may affect the finish. These differences in character are not defects, but distinctions that make each piece of furniture unique.

Our furniture is built to last. Following these steps for basic care should protect your investment for years to come.

- Dust frequently with a clean damp lint-free cloth. This will help remove abrasive build up which can damage the finish over time.
- Avoid exposing your furniture to strong sunlight, heat outlet, open windows or dampness. Prolonged exposure to direct sunlight can fade the finish of your furniture, while extreme temperature and humidity changes can cause cracking or splitting.
- Do not expose your furniture to any liquids. Never allow water to sit on your furniture. Alcohol, nail polish and perfume are also dangerous as they will dissolve the lacquer finish on contact and may require professional repairs.
- Do not allow plastic to come in direct contact with your furniture. Chemicals in the plastic of placemats etc may soften and mark the finish if left in contact with the furniture for a period of time.
- Hot items Note.