

ASSEMBLY INSTRUCTION

Acorn

5 tier Bookcase

ITEM CODE 70818

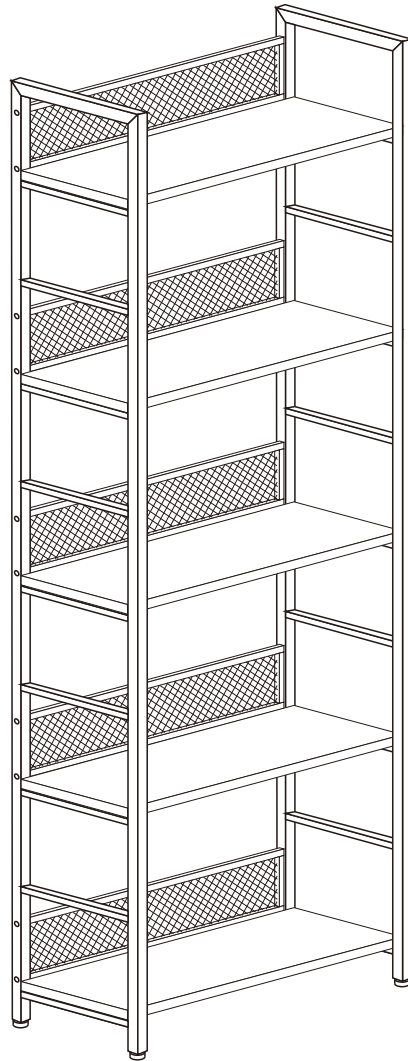

PRE-ASSEMBLY PREPARATION

Before you start:

1. Choose a clean, level, spacious assembly area. Avoid hard surfaces that may damage the product
2. Take care when lifting. Product should be assembled as near as possible to the point of use
3. Ensure that you have all required contents for complete assembly
4. Always read the assembly instructions carefully before beginning assembly.
5. Keep all hardware parts and packaging out of reach of small children.
6. Do not over tighten the screws and bolts as this may damage the threads

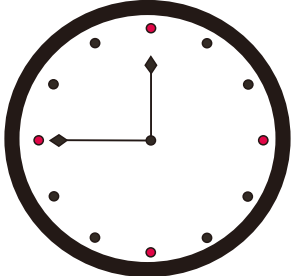
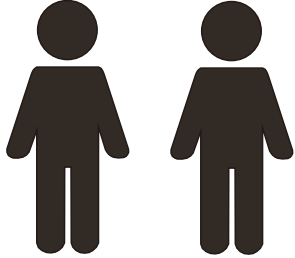
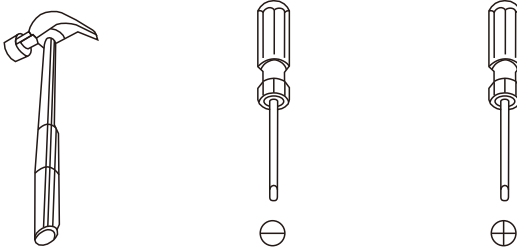
		
Allow 45min	For 2 person	Additional tools required



TIPPING WARNING





Serious or fatal injuries may occur from furniture toppling over. To help avoid this please follow the below recommendations;

- Install the provided "Tipping Kit" as per the instructions
- Never allow children to climb on or hang off of any part of this product
- Unless specifically designed to accommodate, do not set TVs or other heavy objects on top of this product



IF this product has drawers:

- Place the heaviest items in lowest drawers
- Do not open more than 1 drawer at a time as this may cause the product to become unbalanced
- Do not tamper with or remove any drawer interlocking/running system

Note: The use of the provided "Tipping Kit" may reduce but not necessarily eliminate the risk of furniture toppling over. Please use this product with caution.

This is a permanent label. Do not attempt to remove!

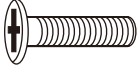
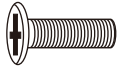
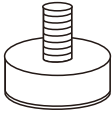
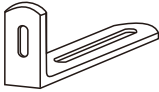
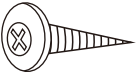
PARTS LIST

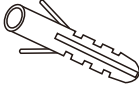
<p>A</p>  <p>M6X30 mm 20pcs</p>	<p>B</p>  <p>M6X20 mm 20pcs</p>	<p>C</p>  <p>M8 4pcs</p>	<p>D</p>  <p>2pcs</p>	<p>E</p>  <p>ST3.5X14mm 4pcs</p>
<p>F</p>  <p>M4X25 mm 2pcs</p>	<p>G</p>  <p>2pcs</p>			

1	Layer Panel 1
2	Layer Panel 2
P1	Metal Frame
P2	Back net

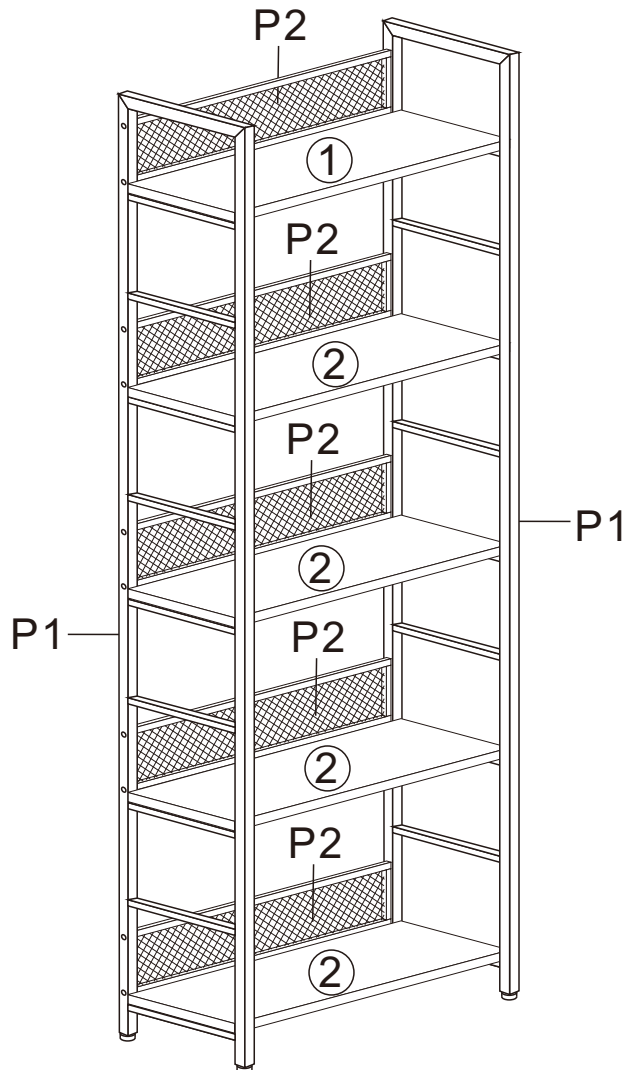

Screw fitting C into the bottom of metal frame P1.

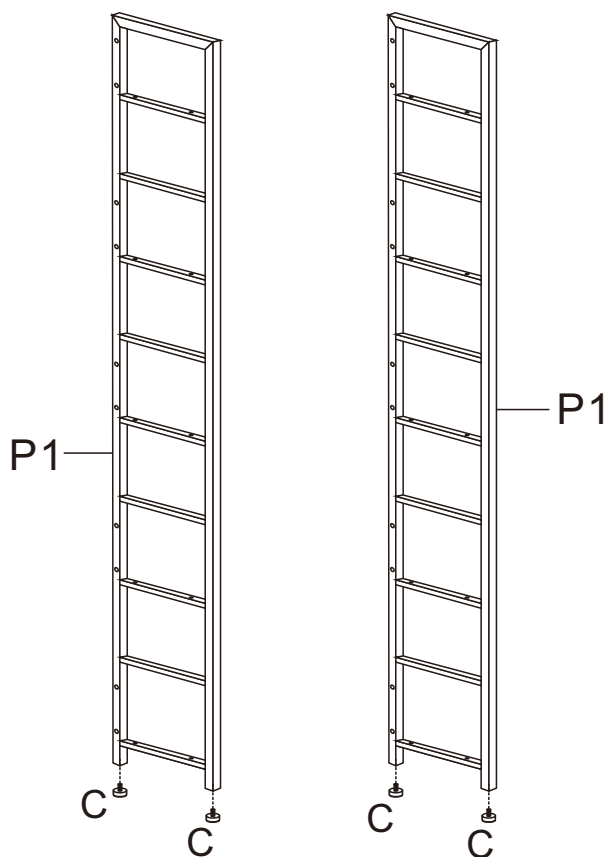

Fix the fitting D to the Panel 1 with fitting E align the corresponding position holes at the bottom of Panel 1.

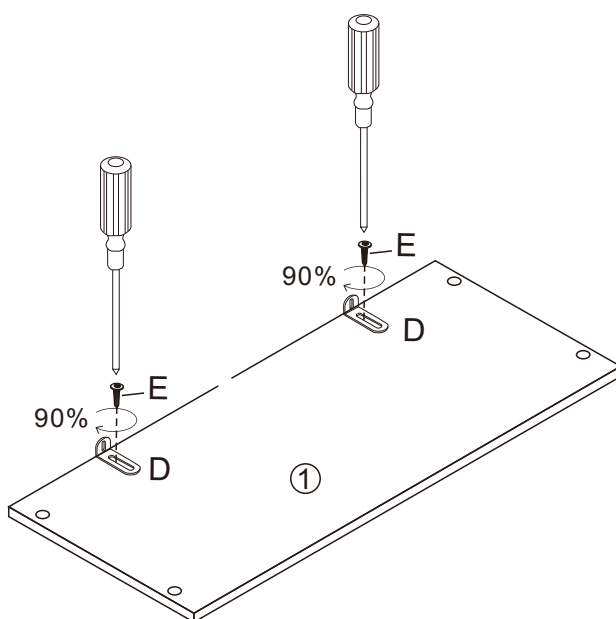

Assemble the back net to the metal frame with fitting A.

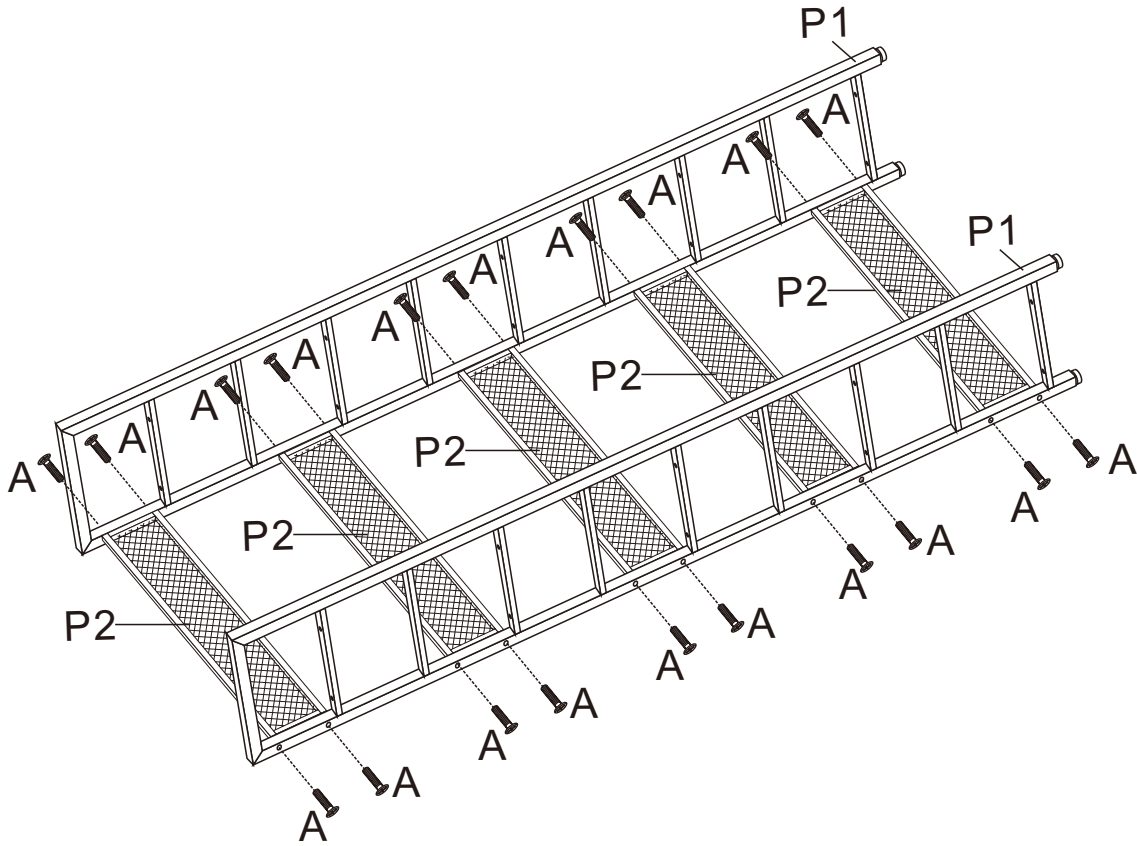

Assemble Panel 1 and 2 to the metal frame with fitting B.

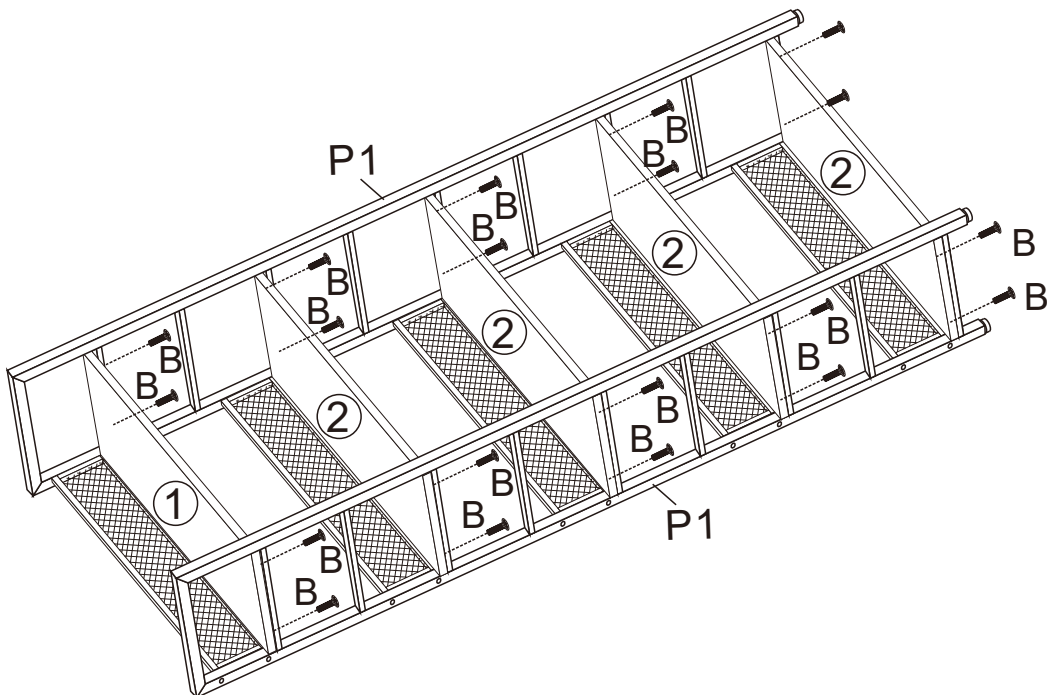

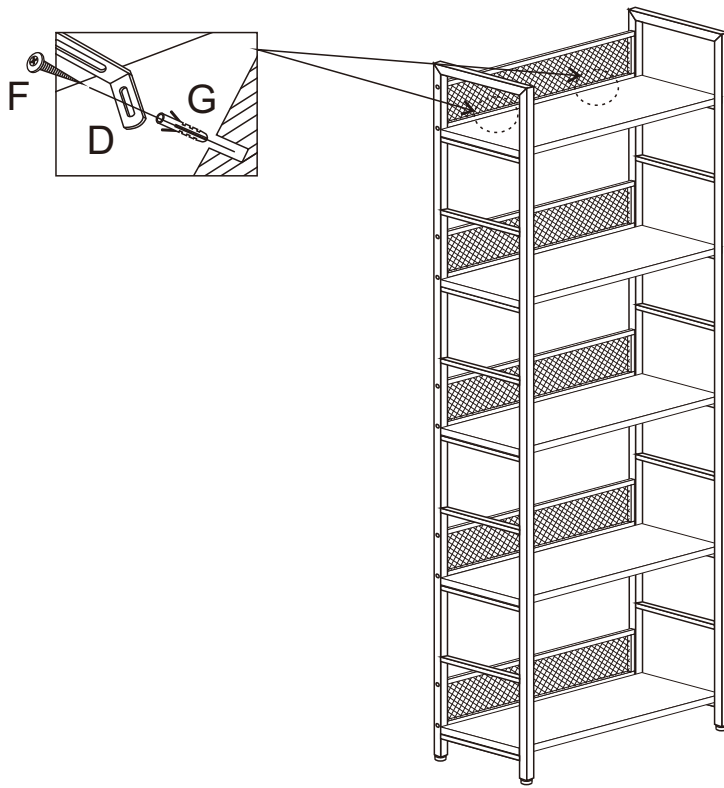

Assembly complete!

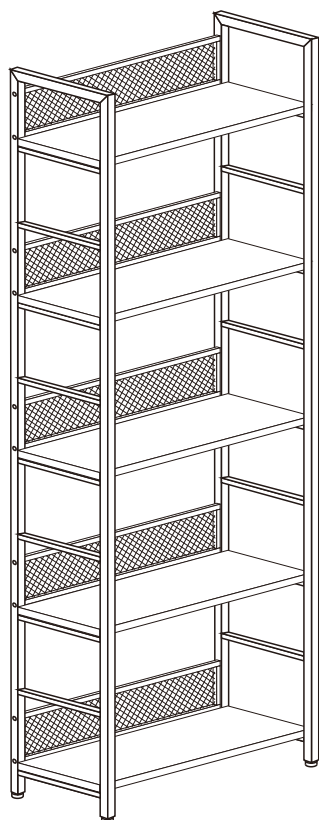

To protect your furniture, we suggest the following:

- Avoid placing your furniture in direct sunlight.
- Do not place furniture directly under windows.
- Do not place sharp materials (knife, fork, etc.) directly onto your furniture as sharp material may scrape and damage the finish.
- Do not place material with high temperature directly onto the surface of your furniture.
- Clean up spills quickly. Water left over a prolonged period of time may cause damage. Alcohol, perfume, nail polishes, aftershave and some medication may cause severe finish damage if not cleaned immediately.
- Use a clean, soft, dry, lint free absorbent cloth to clean your furniture. Do not use any detergent as they may contain ingredients that may react and damage the finish.

NOTE: If the above care advise is not adhered to your product warranty may become void