

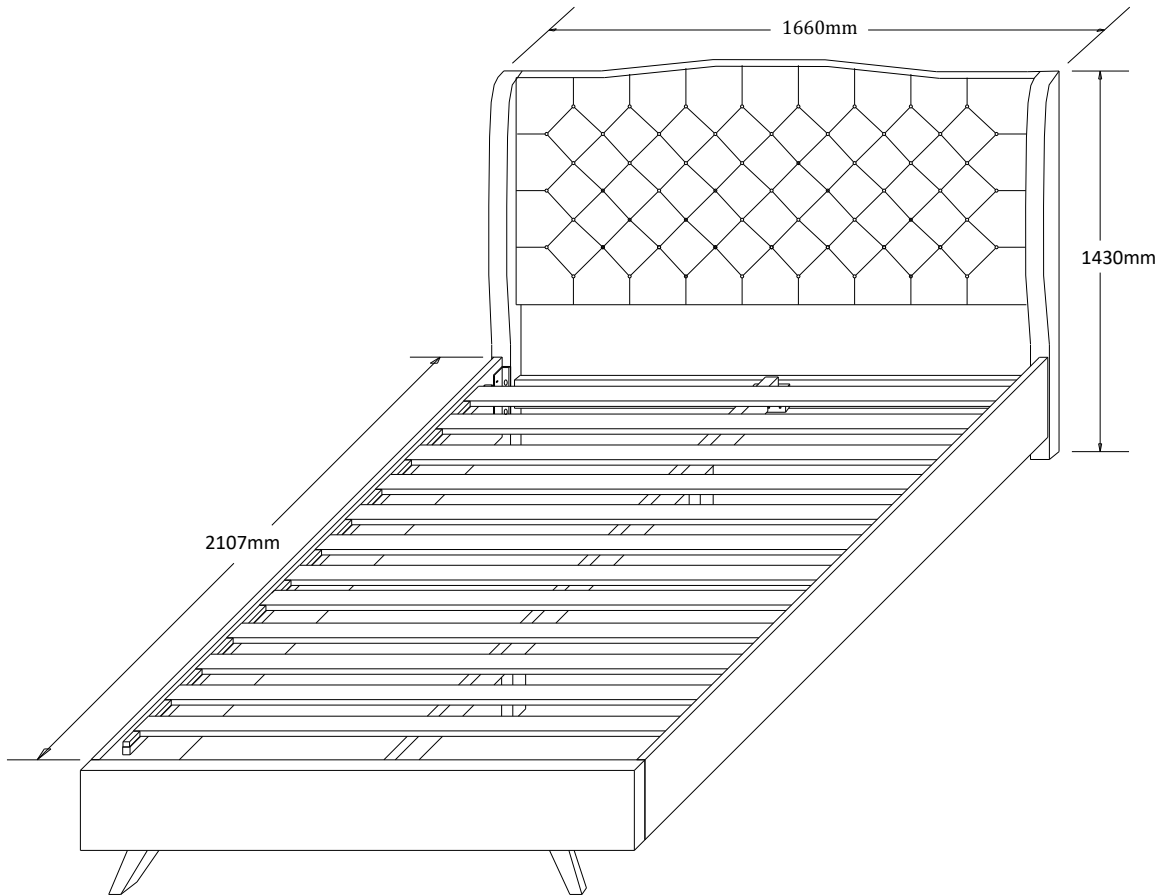

ASSEMBLY INSTRUCTION
ARAGON FABRIC QUEEN BED
ITEM CODE 59637

Imported by Amart Furniture Pty Ltd, Qld, Brisbane Australia.
For any assistance with assembly or for missing parts please
phone Amart Furniture, Customer Service Free call 1800 351
084







Imported by Amart Furniture Pty Ltd, Qld, Brisbane Australia.
For any assistance with assembly or for missing parts please phone
Amart Furniture, Customer Service Free call 1800 351 084

PRE-ASSEMBLY PREPARATION

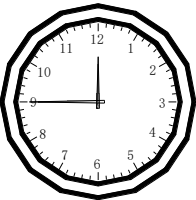
Before you start:

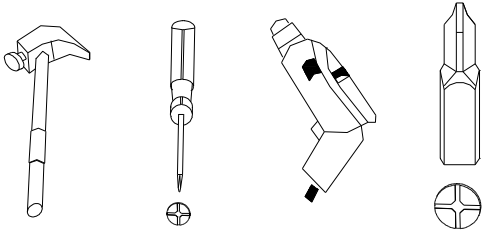
1. Choose a clean, level, spacious assembly area. Avoid hard surfaces that may damage the product
2. Take care when lifting. Product should be assembled as near as possible to the point of use
3. Ensure that you have all required contents for complete assembly
4. Always read the assembly instructions carefully before beginning assembly.
5. Keep all hardware parts and packaging out of reach of small children.
6. Do not over tighten the screws and bolts as this may damage the threads

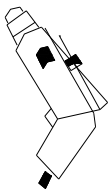
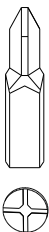
	
ALLOW 45 MINUTES	2 PEOPLE REQUIRED
	
TOOLS REQUIRED	



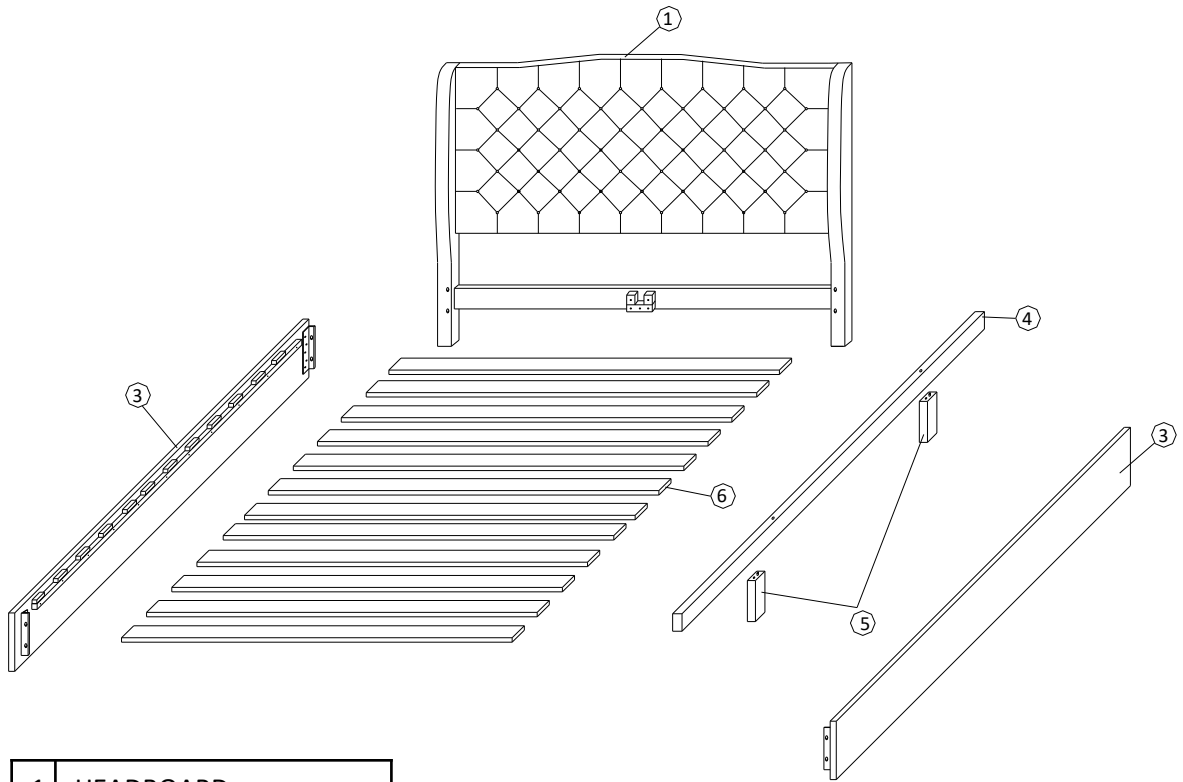

		<p>We recommend using a screwdriver to put this item together. However if you choose to use a power drill it must be used on LOW SPEED (LOW TORQUE) as too much pressure could damage the product</p>
		

PARTS LIST

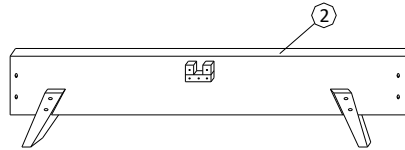

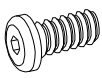
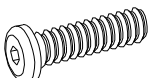
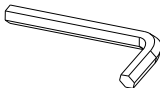

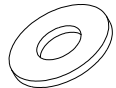
1	HEADBOARD
2	FOOTBOARD
3	SIDERAIL
4	CENTRE RAIL
5	SUPPORT LEGS
6	SLATS (1538mm*88mm)



<p>A. BOLT 5/16"X32MM</p>  <p>8PCS</p>	<p>B. BOLT 5/16"X60MM</p>  <p>2PCS</p>	<p>C. ALLEN KEY</p>  <p>1PCS</p>	<p>D. SCREW 4X30MM</p>  <p>6PCS</p>
<p>E. FLAT WASHER</p>  <p>8PCS</p>	<p>F. LOCK WASHER</p>  <p>8PCS</p>		

ITEMS REQUIRED

1

C. ALLEN KEY	A. BOLT 5/16"X32MM	F. LOCK WASHER	E. FLAT WASHER
			
1PCS	8PCS	8PCS	8PCS

- Attach side rail (3) to headboard (1) and footboard (2) using flat washer (e), lock washer (f) and bolts (a).
- Tighten with Allen Key (c).

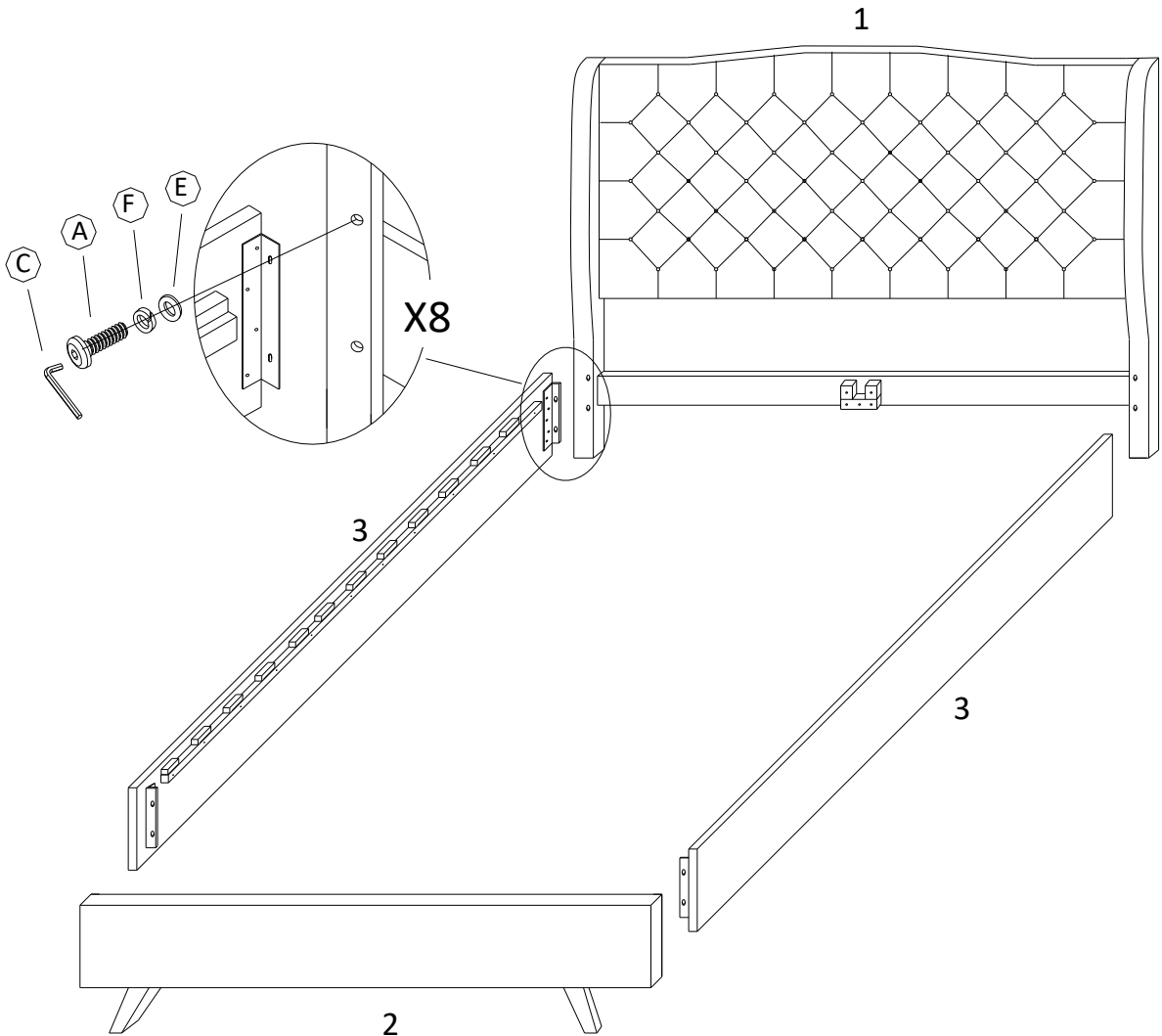

ITEMS REQUIRED

2

C. ALLEN KEY

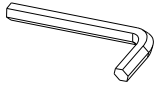

1PCS

B. BOLT 5/16"X60MM

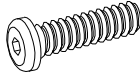

2PCS

- Attach support legs (5) to centre rail (4) with
- bolts (b)
- Tighten with allen key (c)

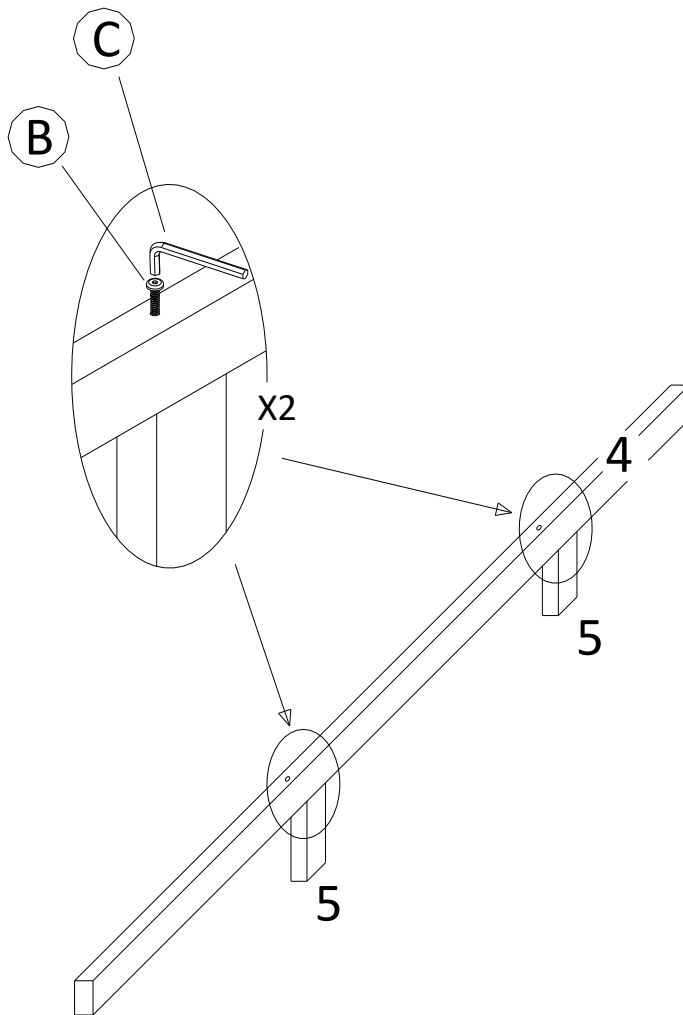

- 3.** Put centre rail (4) between head board (1) and foot board (2) .

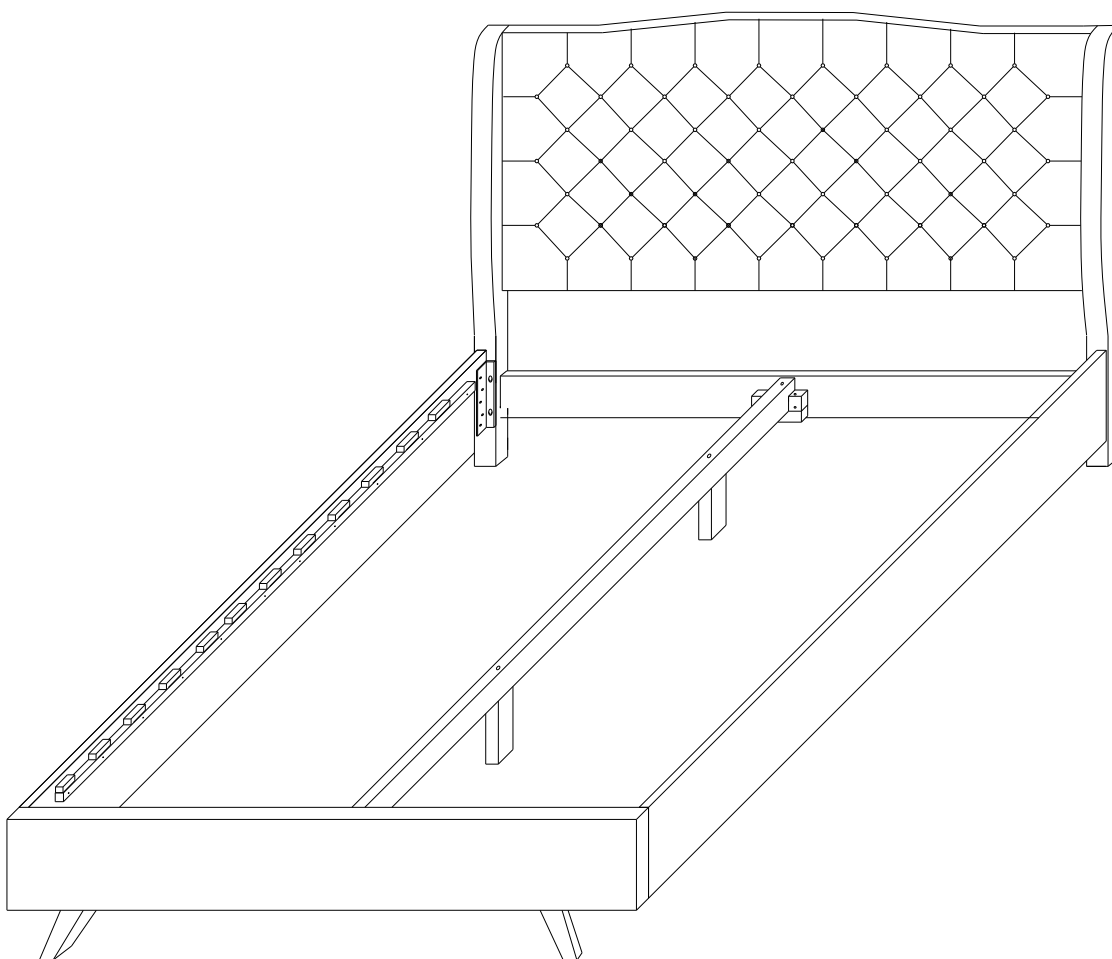

ITEMS REQUIRED

4

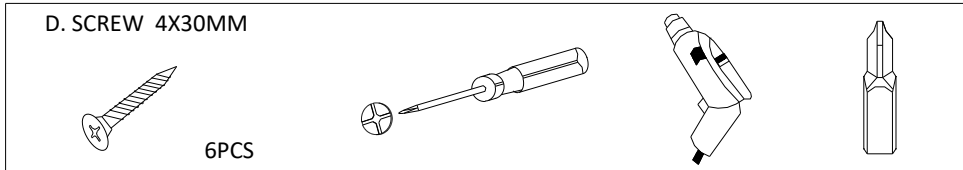

- Attach slats (6) to siderail (3) using screws (d).
- Use Screwdriver or Power Drill on Low Speed.

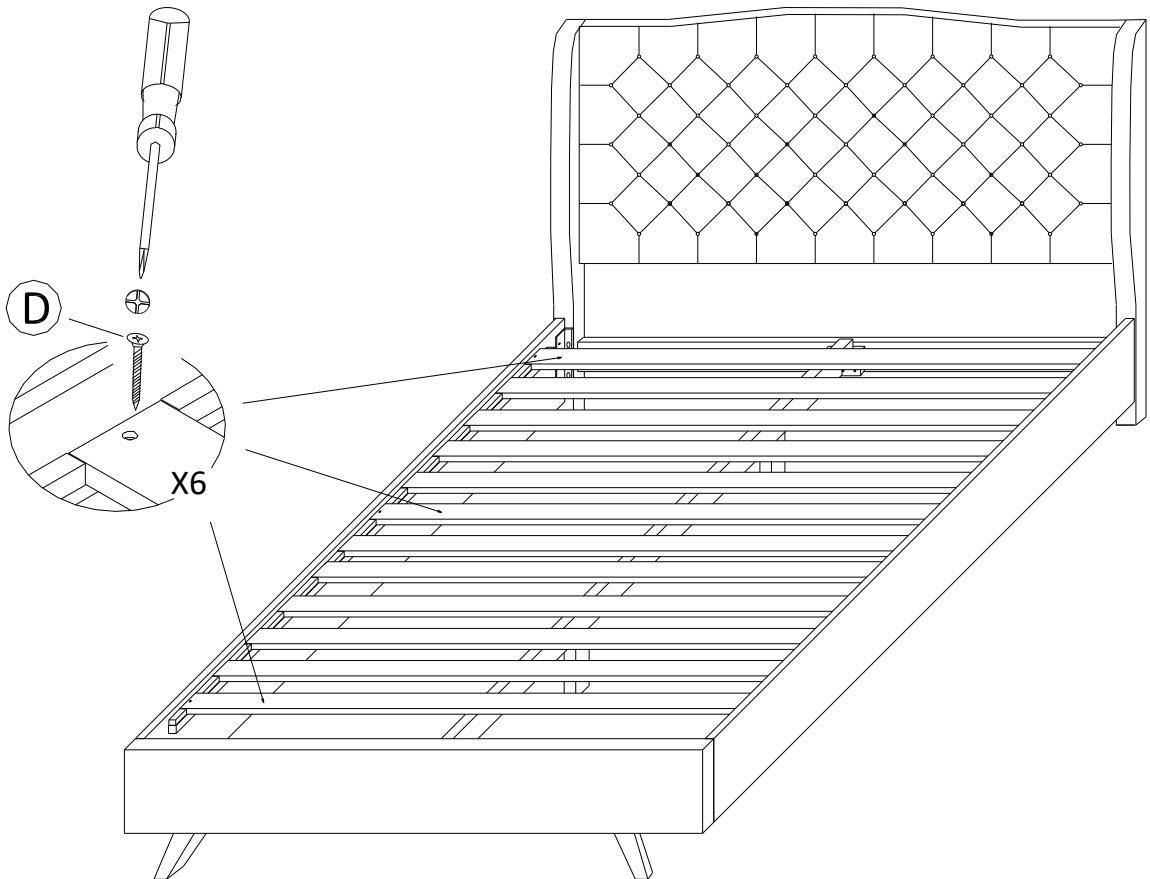

ASSEMBLY IS COMPLETE

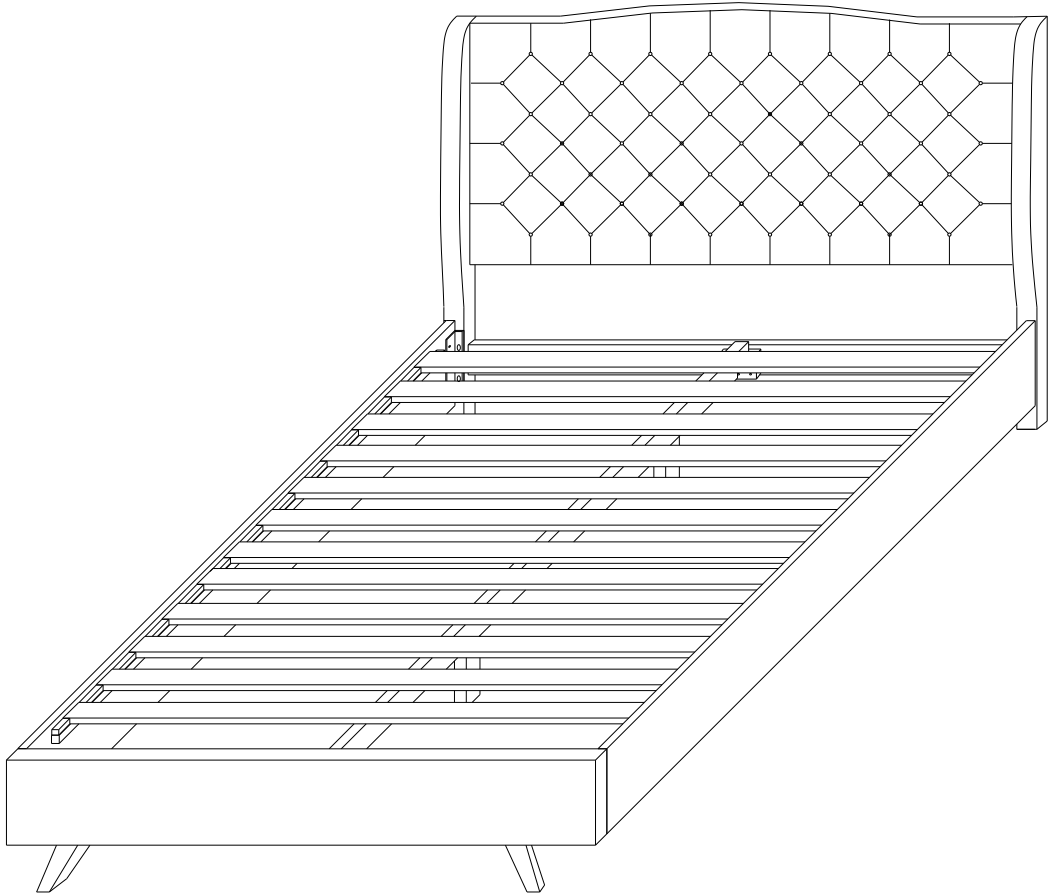

CAUTION

**ALWAYS LIFT YOUR BED WHEN MOVING/RELOCATING – DO NOT DRAG.
DRAGGING CAN CAUSE THE CENTRE SUPPORT LEGS TO BEND/BREAK**

Care and maintenance



REGULAR CARE:

- Protect from direct sunlight
- Vacuum regularly using low suction
- Rotate reversible cushions regularly

CLEANING:

- Do not remove cushion covers for separate cleaning even though they may have zippers
- Do not wash , Do not dry clean , Do not shampoo clean
- Clean with hot water extraction machine. Professional cleaning recommended
- Do not use dishwashing liquid or laundry detergent
- Use only upholstery detergents
- Do not wet filling
- Dry in shade away from direct heat and sunlight
- Allow to dry thoroughly before re-use

SPOT CLEANING:

- Do not rub
- Do not spot clean with any solvent
- Treat spills and stains as soon as possible
- Gently scrape off any soil or mop any liquid from the surface of the fabric
- Apply proprietary cleaning agents strictly according to instructions to remove the residue of the spill
- Do not saturate the fabric or interior with water or other cleaning liquids

WARNING:

Apply only water-based soil resist (fabric protection) treatments. Do not use aerosol products

* PILLING IS NOT A FABRIC DEFECT OR FAULT AND IS NOT COVERED BY WARRANTY

* PILLING IS A NORMAL OCCURRENCE CAUSED BY WEAR AND TEAR AND DOES NOT AFFECT THE DURABILITY OR FUNCTIONALITY OF THE FABRIC AND IS EASILY REMOVED