



ASSEMBLY INSTRUCTION

ELDRIDGE 2 SEATER WITH INBUILT RECLINERS  
U63923

ITEM CODE: 65053

Imported by Amart Furniture Pty Ltd, Qld, Brisbane Australia.

For any assistance with assembly or for missing parts please phone  
Amart Furniture, Customer Service Free call 1800 351 084

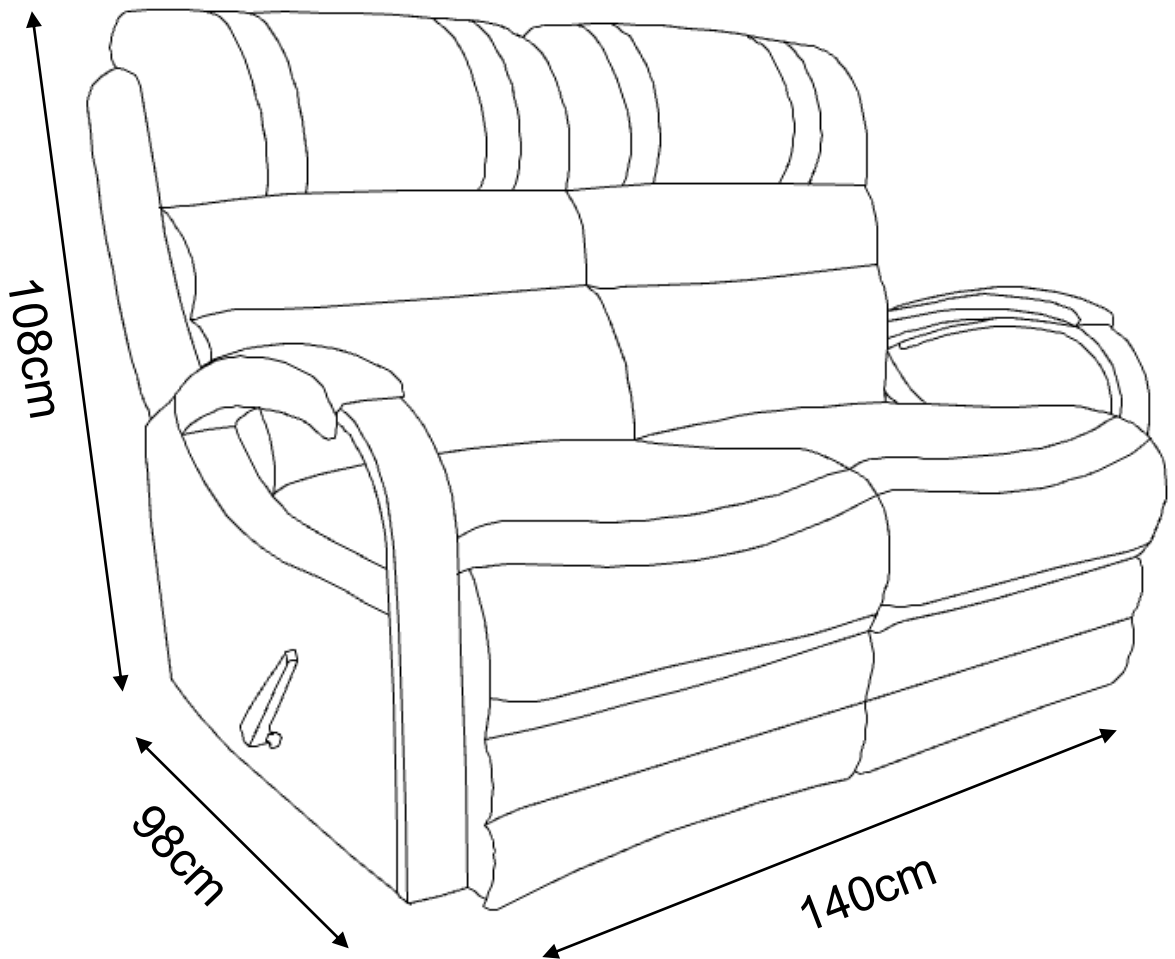

Imported by Amart Furniture Pty Ltd, Qld, Brisbane Australia.

For any assistance with assembly or for missing parts please phone  
Amart Furniture, Customer Service Free call 1800 351 084

## PRE-ASSEMBLY PREPARATION

### Before you start:

1. Choose a clean, level, spacious assembly area. Avoid hard surfaces that may damage the product
2. Take care when lifting. Product should be assembled as near as possible to the point of use
3. Ensure that you have all required contents for complete assembly
4. Always read the assembly instructions carefully before beginning assembly.
5. Keep all hardware parts and packaging out of reach of small children.
6. Do not over tighten the screws and bolts as this may damage the threads

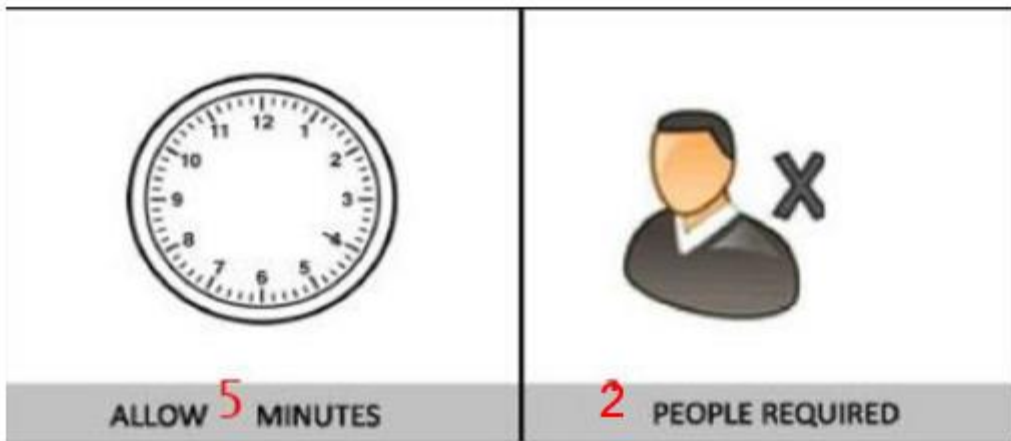

## **WARNING**

Do Not allow children to play on this mechanised furniture or operate the mechanism. Leg rest folds down on closing so that a child could possibly be injured. Always leave in an upright and closed position. Keep hands and feet clear of mechanism. Only the occupant should operate it.

# Parts List

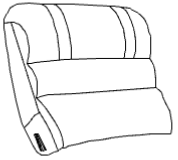
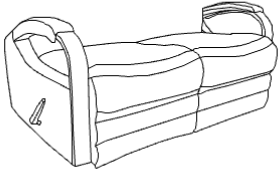
①		Lhf Back	1 PC
②		Rhf Back	1 PC
③		Seat	1 PC

You may need a screwdriver to remove back of recliner

**Caution; Do not allow children to play on motion furniture or operate the mechanisms, Serious injury or death may result. Leg rest folds down upon closing potentially causing crushing, pinching or severing of limbs, The furniture may be unstable in its extended position. If unattended always leave in an upright and closed position. Only adults should operate this mechanism. Always keep hands and feet clear of the mechanism. **CE★RO****

# ASSEMBLY INSTRUCTIONS

STEP 1: Attach back to recliner

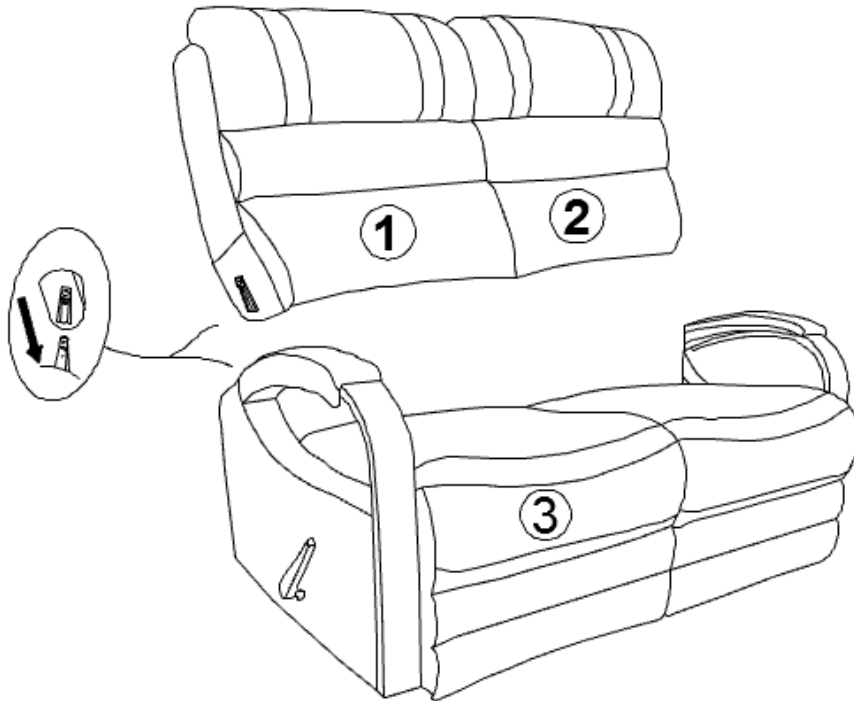

STEP 2: Open the recliner. Assembly complete.

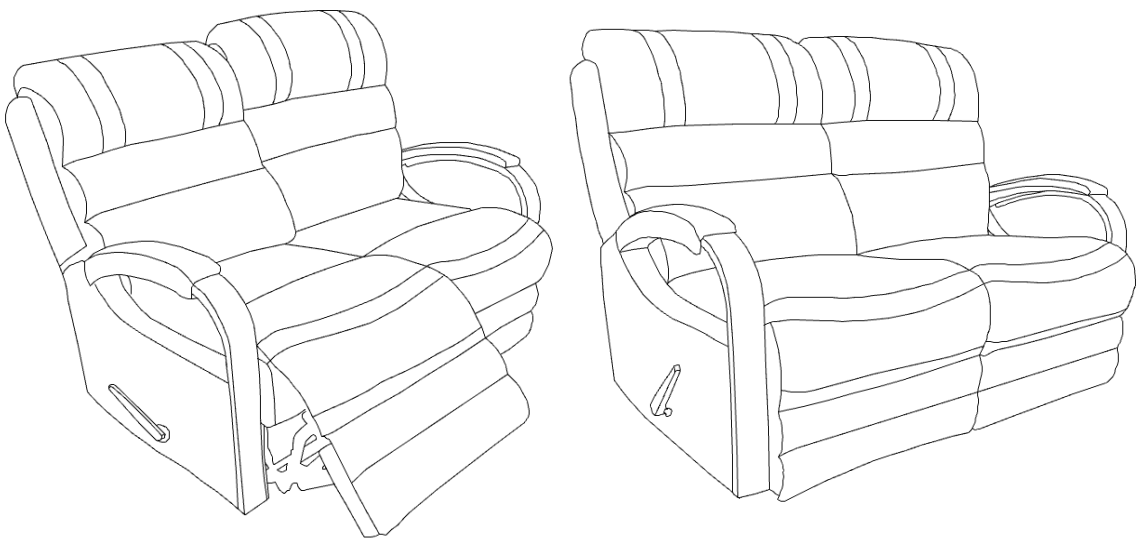

## BACK ASSEMBLY INSTRUCTIONS RECLINER/MOTION UPHOLSTERY

**CAUTION:** PLEASE READ ALL INSTRUCTIONS CAREFULLY BEFORE STARTING THE ASSEMBLY PROCESS

IT IS RECOMMENDED TO USE TWO PEOPLE WHEN ASSEMBLING AND REMOVING THE INSIDE BACKS TO AND FROM THE BASE OF THE FURNITURE.

**STEP 1:** Slide inside back receivers into the steel mechanism posts in the base of the furniture (Figure A).

**STEP 2:** Press both sides of the inside back firmly into place. The inside back automatically locks in place.

**STEP 3:** To remove the inside backs, use a screwdriver pressing outward on the black tab in the metal sleeve (Figure B) on both sides of the inside back and lift the inside back from the base of the furniture.

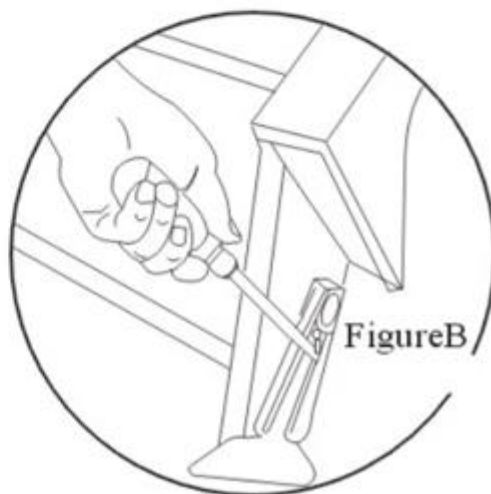
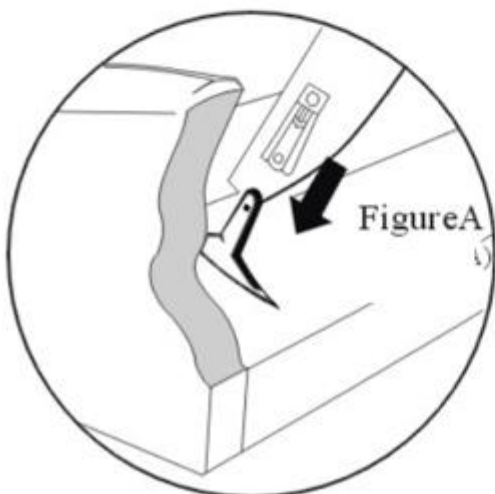

# Fabric Care and Maintenance



---

## **REGULAR CARE:**

- Protect from direct sunlight
- Vacuum regularly using low suction
- Rotate reversible cushions regularly

## **CLEANING:**

- Do not remove cushion covers for separate cleaning even though they may have zippers
- Do not wash, Do not dry clean, Do not shampoo clean
- Clean with hot water extraction machine. Professional cleaning recommended
- Do not use dishwashing liquid or laundry detergent
- Use only upholstery detergents
- Do not wet filling
- Dry in shade away from direct heat and sunlight
- Allow to dry thoroughly before re-use

## **SPOT CLEANING:**

- Do not rub
- Do not spot clean with any solvent
- Treat spills and stains as soon as possible
- Gently scrape off any soil or mop any liquid from the surface of the fabric
- Apply proprietary cleaning agents strictly according to instructions to remove the residue of the spill
- Do not saturate the fabric or interior with water or other cleaning liquids

## **WARNING:**

Apply only water-based soil resist (fabric protection) treatments. Do not use aerosol products

\* PILLING IS NOT A FABRIC DEFECT OR FAULT AND IS NOT COVERED BY WARRANTY

\* PILLING IS A NORMAL OCCURRENCE CAUSED BY WEAR AND TEAR AND DOES NOT AFFECT THE DURABILITY OR FUNCTIONALITY OF THE FABRIC AND IS EASILY REMOVED