



## ASSEMBLY INSTRUCTION

VERENA

ITEM CODE 64295

Imported by Amart Furniture Pty Ltd, Qld, Brisbane Australia.  
For any assistance with assembly or for missing parts please phone  
Amart Furniture, Customer Service Free call 1800 351 084

SIGNATURE  
— COLLECTION —

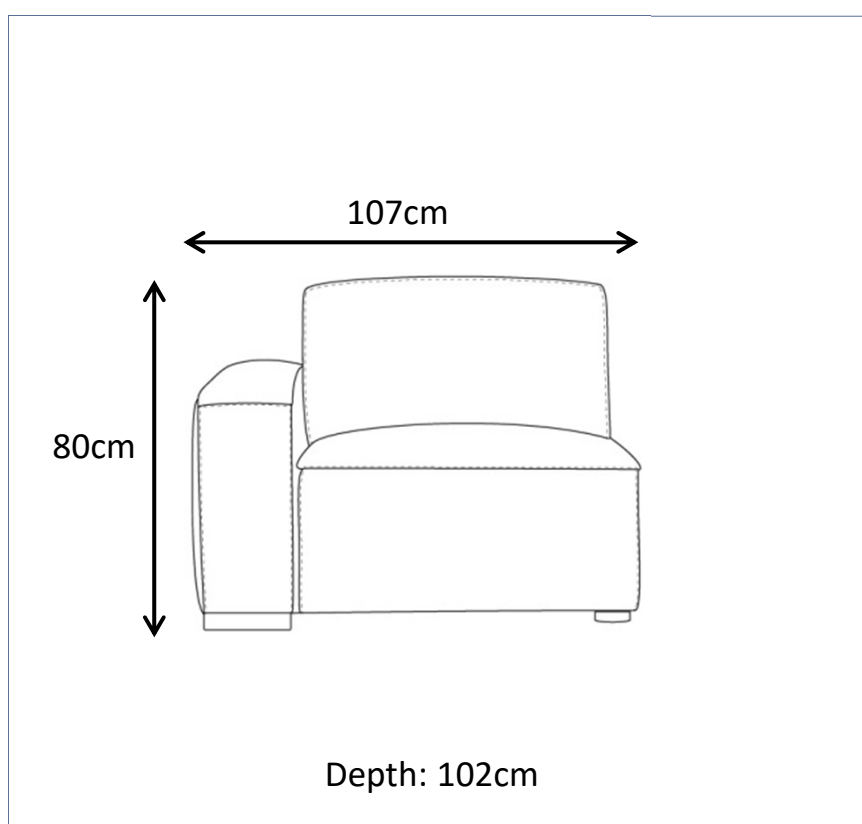



Imported by Amart Furniture Pty Ltd, Qld, Brisbane Australia.  
For any assistance with assembly or for missing parts please phone  
Amart Furniture, Customer Service Free call 1800 351 084

## PRE-ASSEMBLY PREPARATION

### Before you start:

1. Choose a clean, level, spacious assembly area. Avoid hard surfaces that may damage the product
2. Take care when lifting. Product should be assembled as near as possible to the point of use
3. Ensure that you have all required contents for complete assembly
4. Always read the assembly instructions carefully before beginning assembly.
5. Keep all hardware parts and packaging out of reach of small children.
6. Do not over tighten the screws and bolts as this may damage the threads



	
ALLOW 15MINUTES	PEOPLE REQUIRED
ADDITIONAL TOOLS REQUIRED	

**WARNING**  
DO NOT STUB YOUR TOES ON THE  
CONNECTION CLIP POKING OUT FROM THE  
BOTTOM OF THE SOFA.

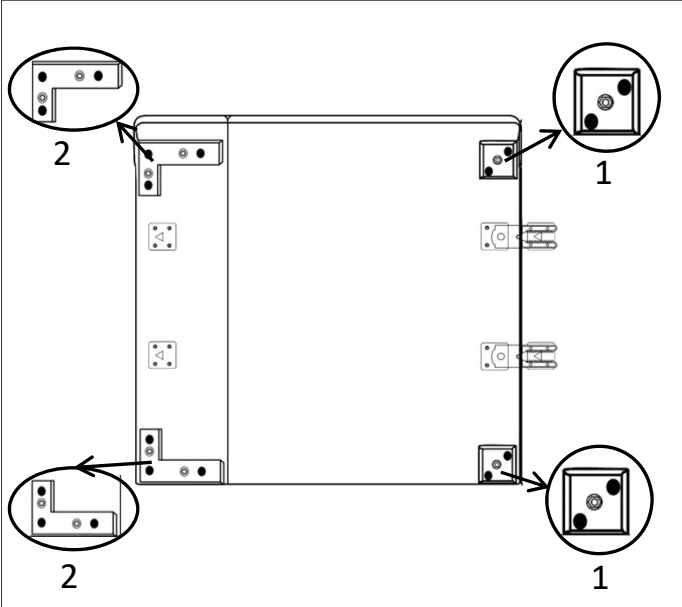
# PARTS LIST

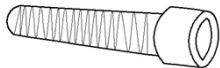

1	SQUARE LEG
2	"L" SHAPE LEG

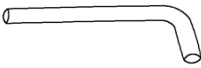
<p>a. Bolt M8X60</p>  <p>6pcs</p>	<p>b. Washer</p>  <p>6pcs</p>	<p>c. Allen Key</p>  <p>1pcs</p>
--	--	--

STEP 1: Tighten the legs **1** to the bottom of LHF chair with bolts(a) and washers(b) by Allen Key(c).

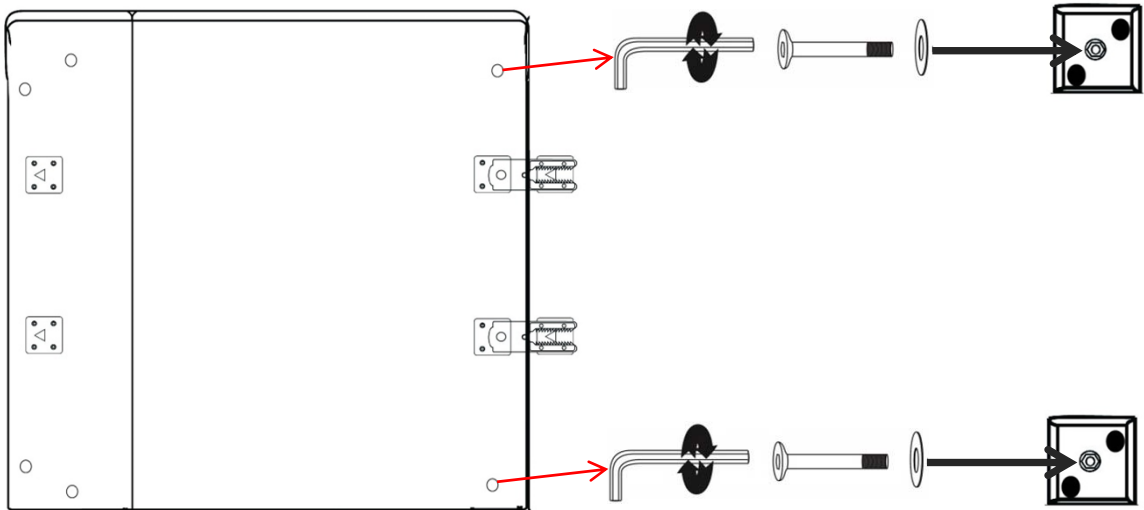

STEP 2: Tighten one pair of leg **2** to the bottom of LHF chair with bolts(a) and washers(b) by Allen Key(c).

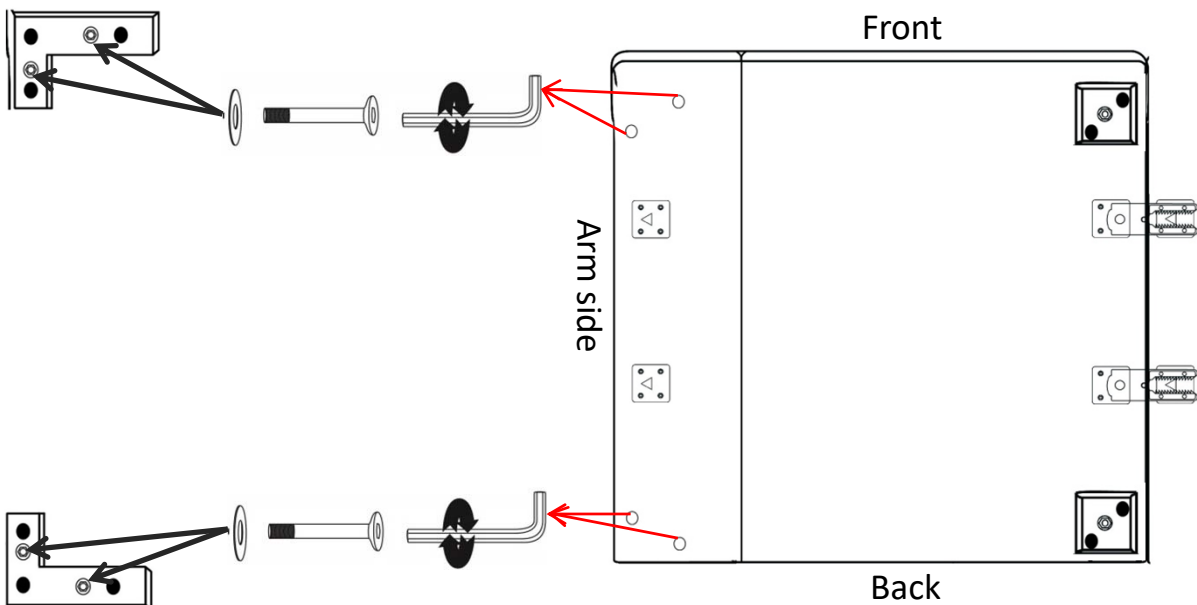

**STEP 3:** Unfold connection clips to poke out from bottom of the sofa. Align your next sofa piece beside the original piece. Extend the clips and ensure the clip and connection pin on both sofa pieces line up. Slide the two pieces together to form a connection.

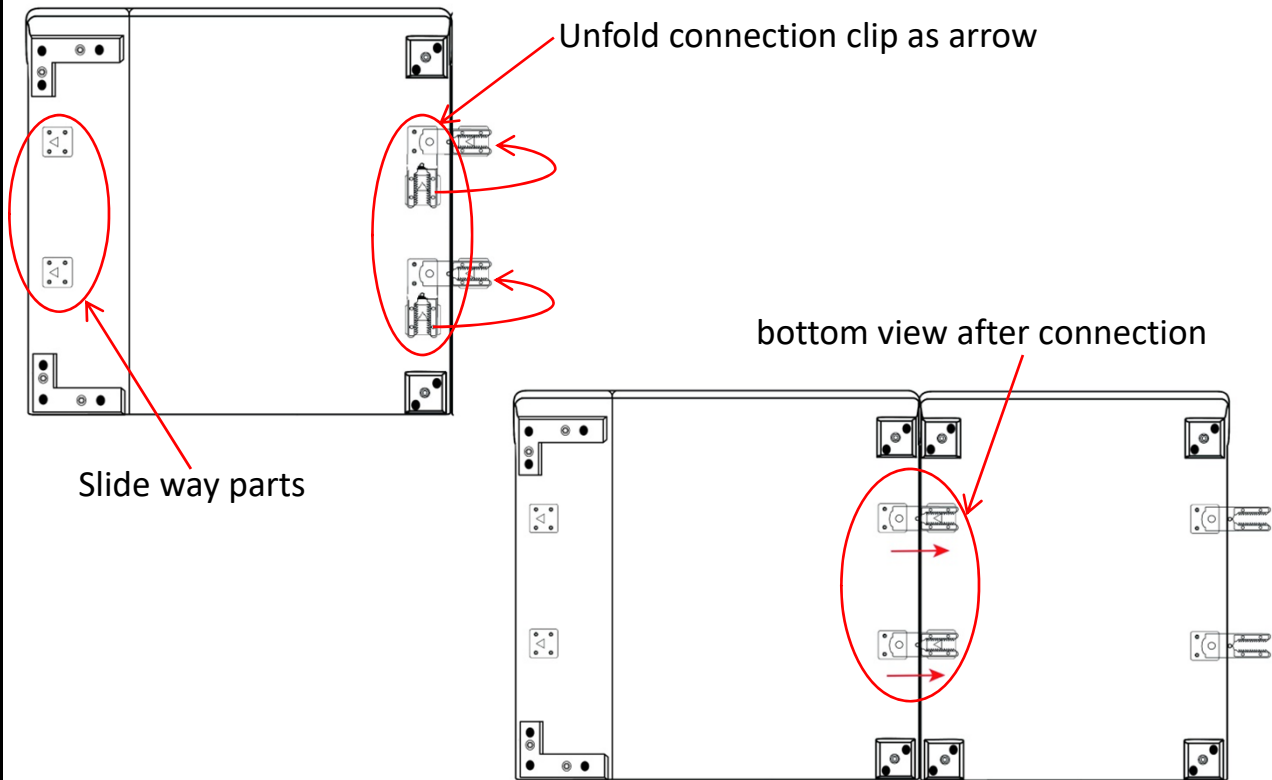

### To Separate Two Lounge Pieces

Use two people to lift the lounge and move clear of the connection clips.

item offering connection clips

item offering slide way parts

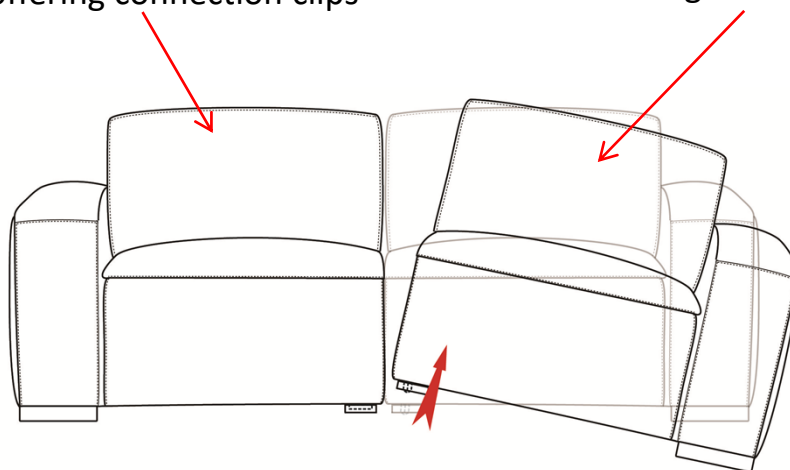

## **CARE AND MAINTENANCE**

### **LEATHER**

WHEN NECESSARY BRUSH OR VACUUM AWAY DUST AND GRIT. WIPE OVER WITH A SOFT, CLEAN, DYEFAST CLOTH.

FOR SPOTS AND SPILLS:  
WIPE EXCESS LIQUID UP IMMEDIATELY WITH AN ABSORBANT CLOTH OR SPONGE.

FOR OVERALL CLEANING:  
WE RECOMMEND CLEANING EVERY 3-4 MONTHS WITH  
· LEATHER CLEANER FOLLOWED BY APPLICATIONS OF  
· LEATHER PROTECTOR.  
ALWAYS FOLLOW DIRECTIONS ON PACKS.

NOTES:  
ACCUMULATION OF PERSPIRATION AND BODY OILS ON ARMPADS, HEADREST ECT. MAY DAMAGE YOUR LEATHER - THESE AREAS MAY REQUIRE MORE FREQUENT CLEANING.

DO NOT EXPOSE LEATHER TO DIRECT SUNLIGHT; INTENSIVE HEAT; WEATHER; OR SOAK UNNECESSARILY. ALWAYS AVOID EXCESSIVE HARD RUBBING.

DO NOT DRY CLEAN OR MACHINE WASH.

DO NOT USE SADDLE SOAP; DETERGENTS; SOLVENTS; ABRASIVES; UNIDENTIFIED LEATHER CLEANERS; SUEDE CLEANERS OR ANY PRODUCTS CONTAINING SILICON OR SOLVENTS.