



## ASSEMBLY INSTRUCTION

ELIJAH

ITEM CODE 58733

Imported by Super Amart Pty Ltd, Qld, Brisbane Australia.

For any assistance with assembly or for missing parts please phone

Super Amart Ewing Road, Customer Service Free call 1800 351 084

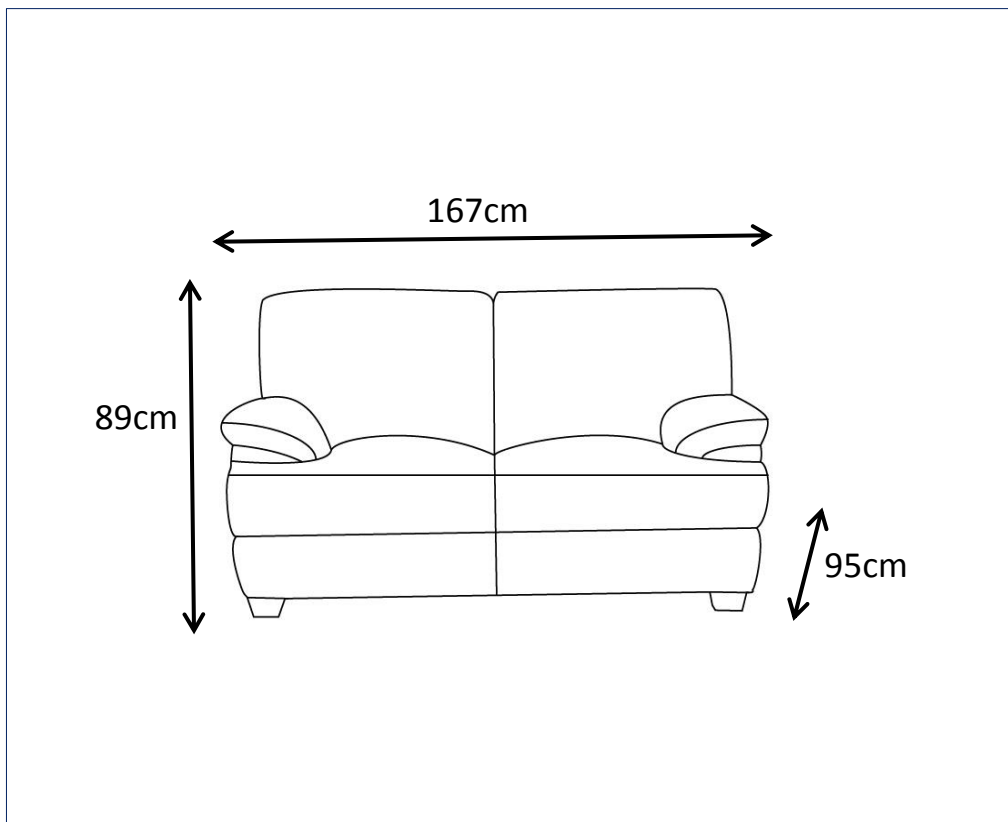

Imported by Super Amart Pty Ltd, Qld, Brisbane Australia.



For any assistance with assembly or for missing parts please phone

Super Amart Ewing Road, Customer Service Free call 1800 351 084

## PRE-ASSEMBLY PREPARATION

### Before you start:



1. Choose a clean, level, spacious assembly area. Avoid hard surfaces that may damage the product
2. Take care when lifting. Product should be assembled as near as possible to the point of use
3. Ensure that you have all required contents for complete assembly
4. Always read the assembly instructions carefully before beginning assembly.
5. Keep all hardware parts and packaging out of reach of small children.
6. Do not over tighten the screws and bolts as this may damage the threads

	
ALLOW 15 MINUTES	PEOPLE REQUIRED
ADDITIONAL TOOLS REQUIRED	

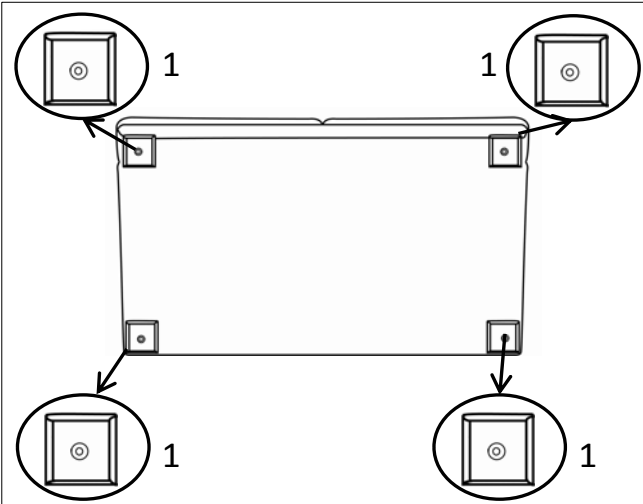
# PARTS LIST



1	FEET
---	------

<p>a. Bolt M8X60</p>  <p>4pcs</p>	<p>b. Washer</p>  <p>4pcs</p>	<p>c. Allen Key</p>  <p>1pcs</p>
----------------------------------------------------------------------------------------------------------------------	------------------------------------------------------------------------------------------------------------------	----------------------------------------------------------------------------------------------------------------------

STEP 1: Tighten the feet① to the bottom of 2-seater with bolts(a) and washers(b) by Allen Key(c)

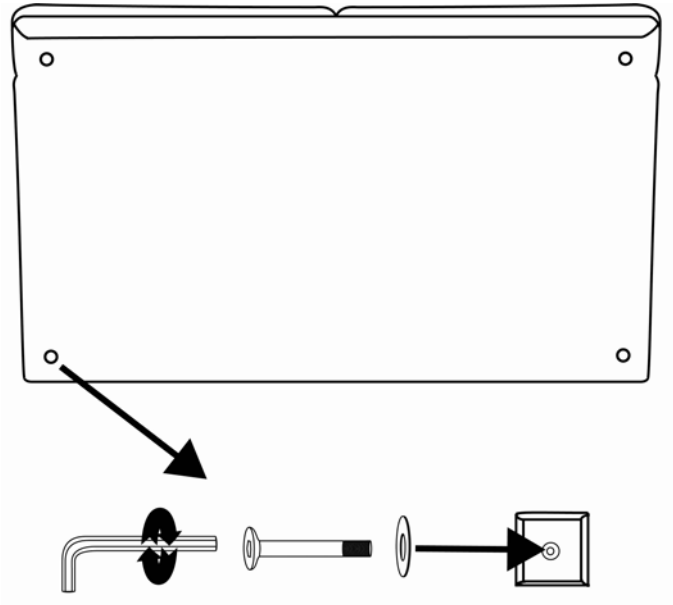

ASSEMBLY IS COMPLETE

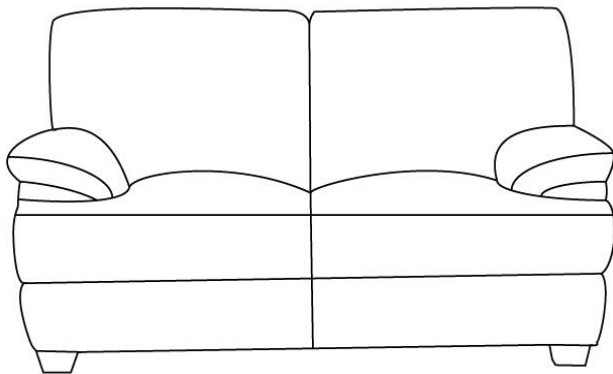

## CARE AND MAINTENANCE

### FABRIC CARE (HEADBOARD)

REGULAR CARE: PROTECT FROM DIRECT SUNLIGHT.  
VACUUM REGULARLY USING LOW SUCTION.  
ROTATE REVERSIBLE CUSHIONS REGULARLY.

#### CLEANING:

DO NOT REMOVE CUSHION COVERS FOR SEPARATE  
CLEANING EVEN THOUGH THEY HAVE ZIPPERS.

DO NOT WASH

DO NOT DRY CLEAN

DO NOT SHAMPOO CLEAN

CLEAN WITH HOT-WATER EXTRACTION MACHINE.

(HOT) PROFESSIONAL CLEANING RECOMMENDED

DO NOT USE DISHWASHING OR LAUNDRY

DETERGENTS

USE ONLY UPHOLSTERY DETERGENTS

DO NOT WET FILLING

DRY IN SHADE AWAY FROM DIRECT HEAT AND

SUNLIGHT

ALLOW TO DRY THOROUGHLY BEFORE RE-USE

#### SPOT CLEANING:

DO NOT RUB

DO NOT SPOT CLEAN WITH ANY SOLVENT.

TREAT SPILLS AND STAINS AS SOON AS POSSIBLE.

GENTLY SCRAPE ANY SOIL OR MOP ANY LIQUID

FROM THE SURFACE OF THE FABRIC.

APPLY PROPRIETARY CLEANING AGENTS STRICTLY

ACCORDING TO INSTRUCTIONS TO REMOVE THE

RESIDUE OF THE SPILL.

DO NOT SATURATE THE FABRIC OR INTERIOR WITH

WATER OR OTHER CLEANING LIQUIDS.

WARNING: APPLY ONLY WATER-BASED SOIL RESIST

(FABRIC PROTECTION) TREATMENTS. DO NOT USE

AEROSOL PRODUCTS.